

crosswater[®]

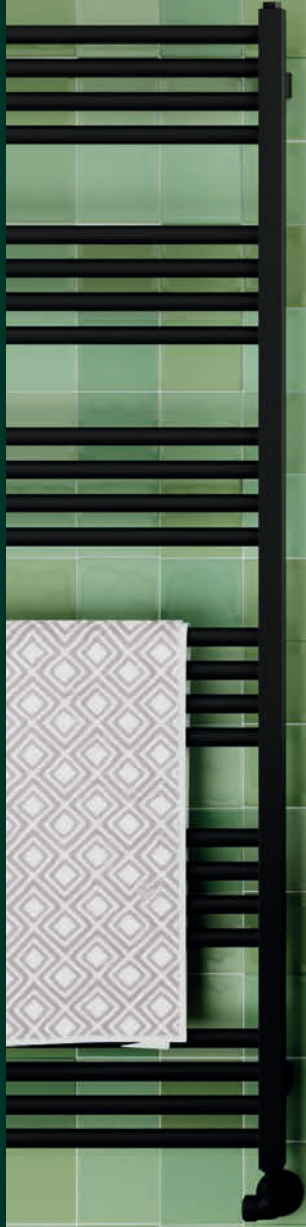

Furniture & Ceramics

March 2022



Bathroom Obsessed

Over many years, we've obsessed over bathroom design, focusing on products that deliver the perfect blend of form and function to make everyday routines a more experiential ritual.

Our eight high-quality design-led furniture collections cater to all the essentials of bathroom storage in creative and clever ways, whatever your design style.

Matched with a comprehensive selection of stylish basin units, mirrors, cabinets, premium towel warmers, performance sanitary ware and luxury finishing touches, you have all the inspiration to create your perfect bathroom experience.

Furniture for Bathrooms

NEW Artist®	8
NEW Glide II	22
NEW Arena	38
NEW Svelte	52
NEW Infinity	64
Zion	74
Kai	80

Basins

NEW Countertop	94
NEW Cloakroom	98
NEW Wall Mounted	100
NEW Undermount & Inset	102
Basin Wastes	104
Overflow Covers	105
Basin & Furniture Traps	105

Toilets

Toilets	
Glide II	108
Kai X	112
NEW Svelte	116
Kai S	120
Kai	124
Support Frames, Cisterns, Flush Plates & Surrounds	
NEW Wall Hung Toilet Support Frames	130
NEW Concealed Toilet Cisterns	132
Flush Plates	134
Frame/Cistern Surround Toilet Furniture	136

Mirrors & Cabinets

Mirrors	
NEW Artist®	140
Glide II	142
Svelte	144
NEW Infinity	146
Dune	148
MPRO	150
Elite	152
Radiance	153

Mirrored Cabinets	
Image	154
Allure	156

Towel Warmers & Controls

Towel Warmers	
NEW Artist	160
NEW Air	161
NEW MPRO Electric	162
MPRO	164
Infinity	166
Wedge	167
Celeste	168
Kai	170
Towel Warmer Controls	
Valves	172
Summer Heating Elements	173



Why Choose Crosswater?



A Perfect Blend Of Form & Function

Over time as bathrooms have evolved into more experiential spaces for relaxation & revitalisation, Crosswater has curated a comprehensive collection of high-quality solutions covering each essential element.



Furniture



Basins & Toilets



Mirrors & Towel Warmers

Often the centrepiece of any bathroom, Crosswater furniture and ceramics are the perfect blend of form and function. Matched with mirrors, cabinets, towel warmers and all the finishing touches, you can truly realise your dream bathroom space.

All Crosswater products are supported by a network of over 1000 approved retailers who can be found at www.crosswater.co.uk





Reassuring Performance, Always

Crosswater's reputation as a leading supplier of high-quality design-led furniture for bathrooms, basins, toilets, mirrors and towel warmers has been built over many years.

We employ a combination of advanced manufacturing techniques, high-quality materials, and finishes to bring you products of the highest possible calibre.

All of the products in this brochure are manufactured to meet and exceed all relevant British and European standards.



Complete Peace Of Mind

We're so sure of the quality of our products that we offer reassuring guarantees on all products in this brochure*

Additionally, a dedicated team of bathroom experts whose knowledge and experience are on hand and ready to help before, during and after your products are installed.

Full warranty terms and conditions are available at www.crosswater.co.uk



*Subject to online registration and exceptions



Choosing Your Furniture

Before looking for furniture, think about what you will need to put away in the bathroom itself. Furniture for bathrooms should be stylish whilst comprising great construction and performance qualities, and above all, have the ability to provide storage space for the entire family. Try to think about the future, as the family grows will you need more space? If so, choose the largest storage furniture to fit your bathroom, then you don't have to try to squeeze extra furniture in later. All Crosswater furniture is recyclable and made from 85% recyclable sources.

1. Choose your size and type

The best furniture includes storage space below whilst the basin sits above. Wall hung furniture means the furniture is off the floor, giving the impression of extra space and a sleeker more stylish bathroom which is easy to clean and ideal for a busy family bathroom. All Crosswater wall mounted furniture is fully load bearing to a minimum 90kg.

Floor standing bathroom furniture can come with cupboard doors or drawers. These units maximise storage by going right down to the floor and can also have the benefit of hiding any unsightly pipe work. All Crosswater floor standing furniture units are supplied pre-assembled and constructed from extremely strong 18mm board.

Additionally, mirrored cabinets are available and combine two must-haves in one, plentiful space for regularly used toiletries or other smaller items that might get lost in larger cupboards and an over basin mirror ideal for helping with make up and shaving. If it's just a simple mirror you require, Crosswater has a wide selection of standard and illuminated versions.

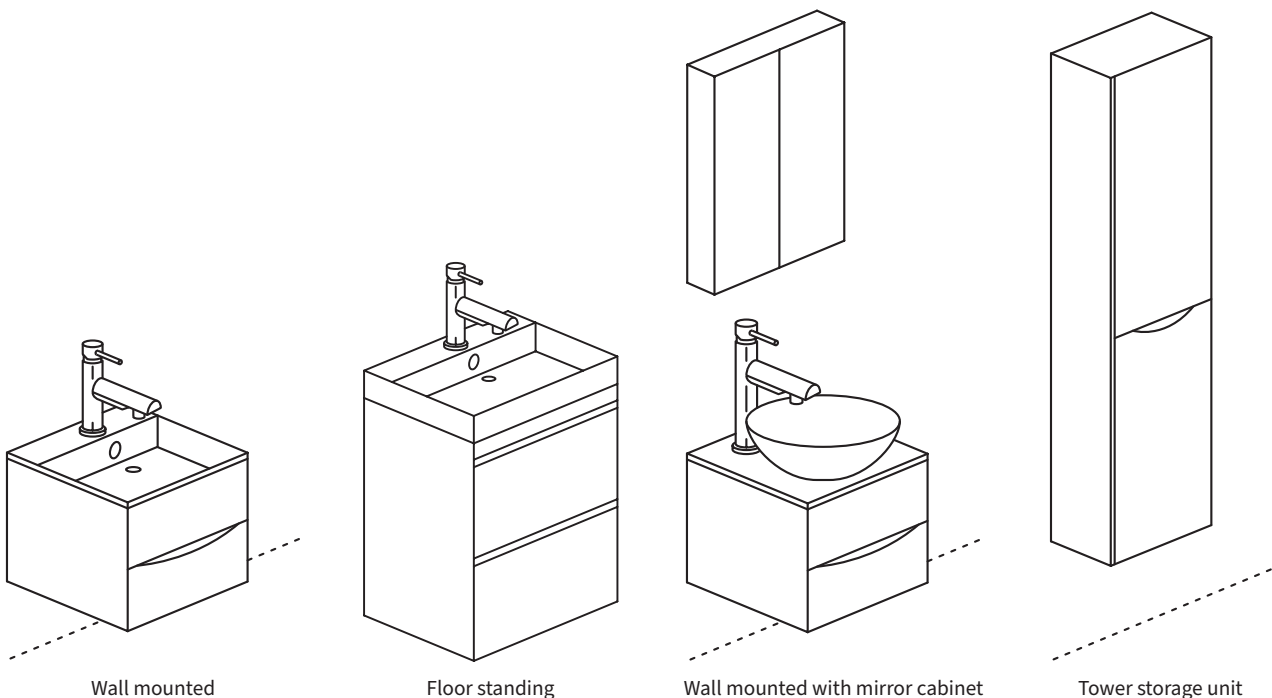

2. Choose your finish

Crosswater offers many styles to match either a modern or traditional bathroom design perfectly. Contemporary bathroom furniture is often white, which will reflect light to make a small bathroom feel bigger. Striving for something different? Look at our Matt Black or Greys, which offer a striking contrast to the basin and toilet. Alternatively, consider adding a more natural feel to your furniture with a choice of wood-look laminate finishes or real wood veneer options.

Choosing Your Finish

Colour Finishes

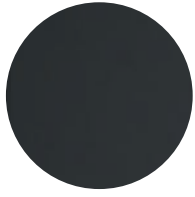

Matt Black
Lacquered finish
ACTIVE antibacterial
Anti fingerprint



Onyx Black
Lacquered finish
PU
Antibacterial
Anti fingerprint & scratch

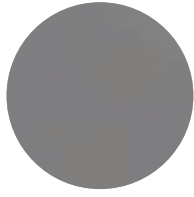

Portland Grey Matt
Laminate finish
PU
Antibacterial
Anti fingerprint

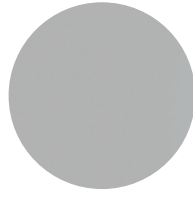

Storm Grey Matt
Lacquered finish
ACTIVE antibacterial
Anti fingerprint

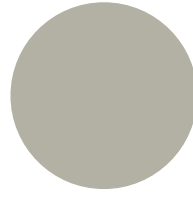

Cashmere Matt
Lacquered finish
ACTIVE antibacterial
Anti fingerprint

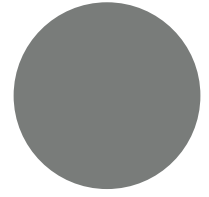

Grey Gloss
Lacquered finish



Pure White Gloss
Laminate finish
PU
Antibacterial



White Gloss
Lacquered finish

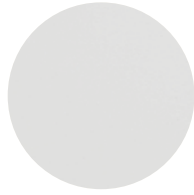

Matt White
Lacquered finish
ACTIVE antibacterial
Anti fingerprint

Authentic Wood Effect Finishes



Steelwood
Authentic wood effect
Matching edging
PU
Antibacterial*



Modern Oak
Authentic wood effect
Matching edging
PU
Antibacterial*



Windsor Oak
Authentic wood effect
Matching edging
PU
Antibacterial*

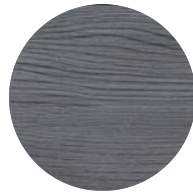

Grey Oak
Authentic wood effect

Real Wood Veneer Finishes



American Walnut
Veneer
Matching edging
PU
Anti UV matt varnish



Grey Ash
Veneer
Matching edging
PU
Anti UV matt varnish



Castilla Oak
Veneer
Matching edging
PU
Anti UV matt varnish

Real Wood Veneers

All Crosswater real wood veneer furniture finishes are produced from sustainable sources with a specially formulated anti-UV varnish to prevent the wood from fading.

The unique nature of real wood veneers means there will always be variance in tone, grain and colour appearance.

This is just part of the enduring beauty of real wood veneer furniture but does mean that when ordering you should consider ordering all components at the same time to get the best chance of sourcing products from a similar batch.

PU

Crosswater veneer, laminate and wood effect finishes feature higher moisture-resistant qualities than ordinary furniture using polyurethane adhesives on the edge finishes. These adhesives also deliver a virtually invisible 'zero bond line' and outstanding thermal stability maximising the lifetime of the product.

ACTIVE





Some finishes feature as standard a ground-breaking non-toxic and permanent antibacterial treatment called ACTIVE guarantees unlimited protection as the treatment is permanent and under tests reduces the proliferation of common bacteria by more than 99%.





Sustainability

All timber products used in our furniture are sourced responsibly and conform to Forest Stewardship Council® Chain of Custody Certification (FSC®). Crosswater timber products are produced from controlled material sources, which are harvested and replaced or allowed to regenerate naturally.



Our Portfolio

	ARTIST*	GLIDE II	ARENA	ARENA CONSOLE
				
Colour Finishes	Onyx Black Storm Grey Matt Cashmere Matt Matt White	Matt Black Storm Grey Matt White Gloss	Portland Grey Matt Pure White	Portland Grey Matt Pure White
Authentic Wood Effect Finishes		Steelwood Windsor Oak	Steelwood Modern Oak	Steelwood Modern Oak
Real Wood Veneer Finishes				
Wall Mounted	●	●	●	●
Floor Standing	Optional legs			
Available widths (mm)	600 800 1000	500 700 1000	600 700 1000	600 700 1000
Tower Units		●		
Toilet Furniture	●	●	●	●
Number of Drawers	1	2	1/2	1
Number of Doors		Optional link door unit*		
Furniture Basin		●	●	●
Worktop	●	●	●	●
Warranty	10 years	10 years	10 years	10 years

SVELTE	INFINITY	ZION	KAI
			
Storm Grey Matt White Gloss	Matt Black Storm Grey Matt Matt White White Gloss	Storm Grey Matt White Gloss	Grey Gloss White Gloss
	Windsor Oak	Windsor Oak	Grey Oak
Castilla Oak American Walnut Grey Ash			
●	●		●
		●	
600 800 1000	up to 1400	600 700 1000	500 600 800 1000
●	●	●	●
2	1 with optional internal drawer	2	
●		●	●
●	●		●
10 years	10 years	10 years	10 years



NEW





ARTIST®

The stunning Artist collection is a perfect blend of form and function which makes high-end furniture for bathrooms more accessible.

Featuring a signature solid oak worktop Artist is truly differentiated. Its fusion of softer, more human styling, textures, colours and natural materials cross typical boundaries.

Depending on brassware selection, it can easily be the centrepiece of a modern, contemporary or classic bathroom space.



10 Year Guarantee*
Peace of mind



Wall mounted unit with oak worktop p 16

Vanity unit with oak worktop p 18

Toilet furniture units p 20



ARTIST®

Product Highlights

1. Fully assembled wall hung unit, with optional legs for wall hung floor standing solution
2. Beautiful shaped drawer front and legs with hand finished solid wood worktop
3. Handleless, soft close, pull to open, full extension drawers with 4 way adjustment (40kg weight capacity)
4. Wall hangers with 2 way adjustment and safety lock (120kg weight capacity when fitted to solid wall)

Finishes



Onyx Black

Lacquered finish
PU
Antibacterial
Anti fingerprint & scratch



Cashmere Matt

Lacquered finish
ACTIVE antibacterial
Anti fingerprint



Storm Grey Matt

Lacquered finish
ACTIVE antibacterial
Anti fingerprint



Matt White

Lacquered finish
ACTIVE antibacterial
Anti fingerprint

Worktop



Solid Oak

Hand selected and finished
FSC® solid oak block construction
Anti UV, antibacterial matt varnish

Legs

With height adjustable feet



Beech



Onyx Black



Cashmere Matt



Storm Grey Matt



Matt White

Drawer Organisers



2 Section

Windsor oak laminate
construction



4 Section

Windsor oak laminate
construction

Artist solid wood worktops and beech veneer legs are produced from sustainable sources with a specially formulated anti-UV varnish to protect the wood and prevent the wood from fading.

The unique nature of real wood means there will always be variance in tone, grain and colour appearance, this is just part of the enduring beauty of real wood.











ARTIST® Wall Mounted Unit with Solid Oak Worktop

600

600 Single Drawer Wall Mounted Unit
w 600 x d 500 x h 500mm (w/ top 520mm)

600 Solid Sessile Oak Worktop
w 610 x d 505 x h 20mm

Onyx Black



NEW
Unit **ART6000DOB** £840
Worktop **ART61000TOAK** £490
£1330

Cashmere Matt



NEW
Unit **ART6000DCM** £840
Worktop **ART61000TOAK** £490
£1330

Storm Grey Matt



NEW
Unit **ART6000DSG** £840
Worktop **ART61000TOAK** £490
£1330

Matt White



NEW
Unit **ART6000DWM** £820
Worktop **ART61000TOAK** £490
£1310

800

800 Single Drawer Wall Mounted Unit
w 800 x d 500 x h 500mm (w/ top 520mm)

800 Solid Sessile Oak Worktop
w 810 x d 505 x h 20mm



NEW
Unit **ART8000DOB** £970
Worktop **ART8100TOAK** £595
£1565



NEW
Unit **ART8000DCM** £970
Worktop **ART8100TOAK** £595
£1565



NEW
Unit **ART8000DSG** £970
Worktop **ART8100TOAK** £595
£1565



NEW
Unit **ART8000DWM** £950
Worktop **ART8100TOAK** £595
£1545

1000

1000 Single Drawer Wall Mounted Unit
w 1000 x d 500 x h 500mm (w/ top 520mm)

1000 Solid Sessile Oak Worktop
w 1010 x d 505 x h 20mm



NEW
Unit **ART1000DOB** £1065
Worktop **ART1010TOAK** £705
£1770



NEW
Unit **ART1000DCM** £1065
Worktop **ART1010TOAK** £705
£1770



NEW
Unit **ART1000DSG** £1065
Worktop **ART1010TOAK** £705
£1770



NEW
Unit **ART1000DWM** £1055
Worktop **ART1010TOAK** £705
£1760

Drawer Organisers must be ordered separately



NEW
2 Section
Windsor Oak
ARTORG2 £150



NEW
4 Section
Windsor Oak
ARTORG4 £175

Mirrors must be ordered separately



NEW
Artist Back Lit Mirror
w 800 x d 30 x h 600mm
For full details see page 140
ART6080 £375



NEW
Artist Back Lit Mirror
w 1000 x d 30 x h 600mm
For full details see page 140
ART60100 £435



All Artist drawers are lined with a windsor oak finish that perfectly matches the optional drawer organisers. These both complement the solid oak worktop.

Complete your look by selecting your perfect basin from our wide range of compatible basins, see page 92 for details.



All Artist worktops are hand selected and finished FSC® solid oak block construction. They are finished with an Anti UV, antibacterial matt varnish for long lasting quality.



ARTIST® Vanity Unit with Solid Oak Worktop

600

600 Single Drawer Vanity Unit
w 600 x d 500 x h 850mm (w/ top 870mm)

600 Solid Sessile Oak Worktop
w 610 x d 505 x h 20mm

Onyx Black



NEW			
Unit	ART6000DOB	£840	
Worktop	ART61000TOAK	£490	
Legs	ARTLEGOAK	£320	
			£1650

800

800 Single Drawer Vanity Unit
w 800 x d 500 x h 850mm (w/ top 870mm)

800 Solid Sessile Oak Worktop
w 810 x d 505 x h 20mm



NEW			
Unit	ART8000DOB	£970	
Worktop	ART8100TOAK	£595	
Legs	ARTLEGOAK	£320	
			£1885

1000

1000 Single Drawer Vanity Unit
w 1000 x d 500 x h 850mm (w/ top 870mm)

1000 Solid Sessile Oak Worktop
w 1010 x d 505 x h 20mm



NEW			
Unit	ART1000DOB	£1065	
Worktop	ART1010TOAK	£705	
Legs	ARTLEGOAK	£320	
			£2090

Alternative Legs

Pair of Colour Matching Legs
As an alternative to our beech legs we offer legs in matching colours

Compatible with any Artist™ vanity unit



NEW			
Legs	ARTLEGSOB	£290	
			Please note you will also need to order your chosen size of unit and worktop separately

Cashmere Matt



NEW			
Unit	ART6000DCM	£840	
Worktop	ART61000TOAK	£490	
Legs	ARTLEGOAK	£320	
			£1650



NEW			
Unit	ART8000DCM	£970	
Worktop	ART8100TOAK	£595	
Legs	ARTLEGOAK	£320	
			£1885



NEW			
Unit	ART1000DCM	£1065	
Worktop	ART1010TOAK	£705	
Legs	ARTLEGOAK	£320	
			£2090



NEW			
Legs	ARTLEGSCM	£290	
			Please note you will also need to order your chosen size of unit and worktop separately

Storm Grey Matt



NEW			
Unit	ART6000DSG	£840	
Worktop	ART61000TOAK	£490	
Legs	ARTLEGOAK	£320	
			£1650



NEW			
Unit	ART8000DSG	£970	
Worktop	ART8100TOAK	£595	
Legs	ARTLEGOAK	£320	
			£1885



NEW			
Unit	ART1000DSG	£1065	
Worktop	ART1010TOAK	£705	
Legs	ARTLEGOAK	£320	
			£2090



NEW			
Legs	ARTLEGSSG	£290	
			Please note you will also need to order your chosen size of unit and worktop separately

Matt White



NEW			
Unit	ART6000DWM	£820	
Worktop	ART61000TOAK	£490	
Legs	ARTLEGOAK	£320	
			£1630



NEW			
Unit	ART8000DWM	£950	
Worktop	ART8100TOAK	£595	
Legs	ARTLEGOAK	£320	
			£1865



NEW			
Unit	ART1000DWM	£1055	
Worktop	ART1010TOAK	£705	
Legs	ARTLEGOAK	£320	
			£2080



NEW			
Legs	ARTLEGSMW	£320	
			Please note you will also need to order your chosen size of unit and worktop separately

Drawer Organisers must be ordered separately



NEW			
2 Section			
			Windsor Oak
ARTORG2	£150		



NEW			
4 Section			
			Windsor Oak
ARTORG4	£175		

Mirrors must be ordered separately



NEW			
Artist Back Lit Mirror			
			w 800 x d 30 x h 600mm
			For full details see page 140
ART6080	£375		



NEW			
Artist Back Lit Mirror			
			w 1000 x d 30 x h 600mm
			For full details see page 140
ART60100	£435		



All Artist drawers are lined with a windsor oak finish that perfectly matches the optional drawer organisers. These both complement the solid oak worktop and beech leg option.



ARTIST® Toilet Furniture Units

Toilet Furniture Units

Uncut fascia with removable top and adjustable feet. Suitable for toilet frame WCF82X50+ and concealed cisterns WCC47X46+2 or WCC33X31+. Requires assembly before installation.



NEW
Onyx Black

w 545 x d 225 x h 920mm

SP5492OB £255



NEW
Cashmere Matt

w 545 x d 225 x h 920mm

SP5492CM £255



Storm Grey Matt

w 545 x d 225 x h 920mm

SP5492SG £255



NEW
Matt White

w 545 x d 225 x h 920mm

SP5492WM £255

Drawer Organisers must be ordered separately



NEW
2 Section

Windsor Oak

ARTORG2 £150



NEW
4 Section

Windsor Oak

ARTORG4 £175

Mirrors must be ordered separately



NEW
Artist Back Lit Mirror

w 800 x d 30 x h 600mm
For full details see page 140

ART6080 £375



NEW
Artist Back Lit Mirror

w 1000 x d 30 x h 600mm
For full details see page 140

ART60100 £435

Recommended Basins see page 92 for our full list of compatible basins



NEW
Nepi

w 400 x d 400 x h 150mm

IN84100UCW £455



NEW
Circus Brushed Brass Effect

w 400 x d 400 x h 150mm

CT4084UCF £990



NEW
Circus Brushed Stainless Steel Effect

w 400 x d 400 x h 150mm

CT4084UCV £990



NEW
Circus

w 400 x d 400 x h 150mm

CT4084UCW £320



Castellon Carrara Marble/White

w 430 x d 430 x h 148mm

CT0012BSCM+ £700



NEW
Castellon Mini

w 350 x d 350 x h 140mm

CT4015SCW £175



NEW
Navona

w 450 x d 350 x h 120mm

CT08801SCW £400



NEW
Calpe

w 400 x d 400 x h 115mm

CT4090UCW £435

Trap Fittings



Short Furniture Trap

Height adjustable. 40.6L/min flow rate
Fits 32-43mm waste pipe
50mm water seal
Conforms to BS EN 274-1:2002

BTR0510W £30

Perfect Match Towel Warmers

We also offer a range of Artist towel warmers that are a perfect match, see page 160 for details.

Specially designed to complement our Artist furniture units in colour and style with an optional solid oak shelf that matches the solid oak Artist furniture worktop.



NEW

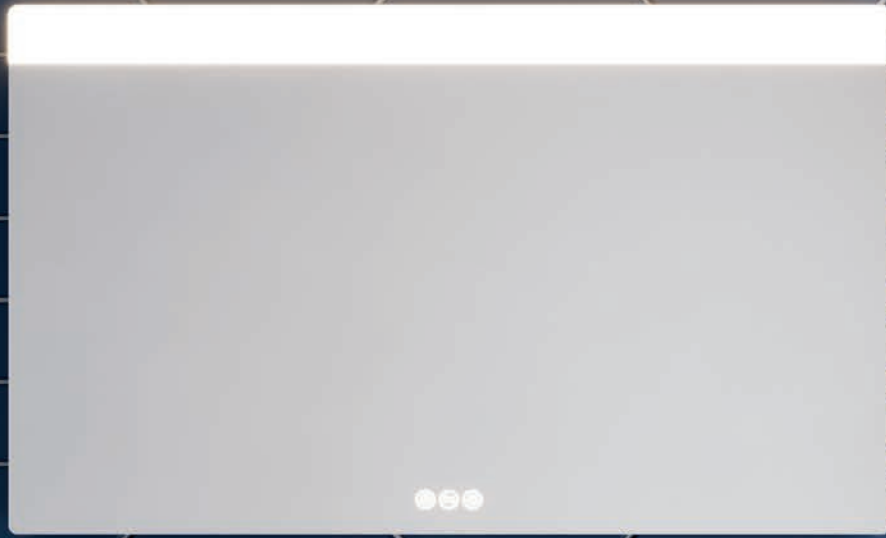



GLIDE II

Reflecting time-honoured cabinet making skills. Glide II epitomises elegant design. Classically styled with fully extendable drawers that enable easy access to the contents, each feature displays the ultimate in function.



10 Year Guarantee*
Peace of mind

Carrara marble effect worktop and link unit p 26

Midnight black glass basin p 28

Ice white glass basin p 30

Mineral marble basin p 32

Ceramic basin p 34

Wall hung tower and toilet furniture units p 36



GLIDE II

Product Highlights

1. Fully assembled
2. Soft close, pull to open, full extension drawers with 2 way adjustment (35kg weight capacity)
3. Wall hangers with 2 way adjustment and safety lock (120kg weight capacity when fitted to solid wall)
4. Top drawer cut out for services

Finishes

All our finishes are designed to be visually striking whilst offering high levels of durability. They are manufactured from 80% renewable sources.



Steelwood
Authentic wood effect
Matching edging
PU
Antibacterial*



Windsor Oak
Authentic wood effect
Matching edging
PU
Antibacterial*



Matt Black
Lacquered finish
ACTIVE antibacterial
Anti fingerprint



Storm Grey Matt
Lacquered finish
ACTIVE antibacterial
Anti fingerprint



White Gloss
Lacquered finish
ACTIVE antibacterial

Basins



Midnight Black Glass
Handcast from low iron soda silicate glass
Matt finish



Ice White Glass
Handcast from low iron soda silicate glass
Gloss finish



Cast Mineral Marble
High gloss white
Integral overflow with chrome cover



Ceramic
White vitreous china
Overflow colour options available see p 105

Worktop

Our solid surface worktops are highly heat resistant, impenetrable to dust, dirt and bacteria making them easy to clean.



Carrara Marble Effect
Easy clean solid surface
Supplied undrilled

Optional Link Unit with push to open door

Up to 2 modular link units can be combined with any size Glide II drawer unit and Carrara Marble Effect worktop to create your perfect storage combination. See page 27 for configuration options.



Steelwood



Windsor Oak



Matt Black



Storm Grey Matt























White Gloss

* tested according to JIS Z 2801/ISO22196



GLIDE II Wall Mounted Unit with Carrara Marble Effect Worktop

500		700		1000		Link Unit	
500 Double Drawer Unit w 500 x d 450 x h 520mm (w/ top 545mm)		700 Double Drawer Unit w 700 x d 450 x h 520mm (w/ top 545mm)		1000 Double Drawer Unit w 1000 x d 450 x h 520mm (w/ top 545mm)		200 Push to Open Door Unit w 200 x d 450 x h 520mm (w/ top 545mm) Use up to 2 door units with a drawer unit Can be positioned left or right	
500 Worktop w 510 x d 455 x h 25mm		700 Worktop w 710 x d 455 x h 25mm		1000 Worktop w 1010 x d 455 x h 25mm			
Steelwood							
NEW		NEW		NEW		NEW	
Unit	GL5000DST+ £780	Unit	GL7000DST+ £865	Unit	GL1000DST+ £955	Link Unit	GL2000FST £395
Worktop	GL5000TMC £480	Worktop	GL7000TMC £600	Worktop	GL1000TMC £670		
£1260		£1465		£1625			
Windsor Oak							
NEW		NEW		NEW		NEW	
Unit	GL5000DWO+ £715	Unit	GL7000DWO+ £805	Unit	GL1000DWO+ £870	Link Unit	GL2000FWO £395
Worktop	GL5000TMC £480	Worktop	GL7000TMC £600	Worktop	GL1000TMC £670		
£1195		£1405		£1540			
Matt Black							
NEW		NEW		NEW		NEW	
Unit	GL5000DBM+ £895	Unit	GL7000DBM+ £955	Unit	GL1000DBM+ £1095	Link Unit	GL2000FMB £435
Worktop	GL5000TMC £480	Worktop	GL7000TMC £600	Worktop	GL1000TMC £670		
£1375		£1555		£1765			
Storm Grey Matt							
NEW		NEW		NEW		NEW	
Unit	GL5000DSG+ £785	Unit	GL7000DSG+ £865	Unit	GL1000DSG+ £960	Link Unit	GL2000FSG £435
Worktop	GL5000TMC £480	Worktop	GL7000TMC £600	Worktop	GL1000TMC £670		
£1265		£1465		£1630			
White Gloss							
NEW		NEW		NEW		NEW	
Unit	GL5000DWG+ £730	Unit	GL7000DWG+ £785	Unit	GL1000DWG+ £870	Link Unit	GL2000FWG £395
Worktop	GL5000TMC £480	Worktop	GL7000TMC £600	Worktop	GL1000TMC £670		
£1210		£1385		£1540			

Full Range of Worktops

When using a link unit you will need a larger worktop, select the correct size from our below options. Our worktops are highly heat resistant, impenetrable to dust, dirt and bacteria and easy to clean. Simply drill on site for basin waste and tap fittings. All worktops are 25mm thick, 455mm deep and supplied undrilled. Please see our website for more details.

510mm	GL5000TMC	£480	910mm	GL9100TMC	£710	NEW	1110mm	GL1100TMC	£855	NEW	1410mm	GL1410TMC	£895	NEW
710mm	GL7000TMC	£600	1010mm	GL1000TMC	£670		1210mm	GL1210TMC	£850	NEW				

Optional Link Unit Layouts

Glide II link units can be used in combination with our Glide II drawer units to create layouts from 700mm to 1400mm wide. Please use the below to design the perfect storage solution for your bathroom space:



700 Layout

- 1 x 500 drawer unit
- 1 x link unit (left or right)
- 1 x 700mm worktop



900 Layout

- 1 x 500 drawer unit
- 2 x link units (left, right or one each side)
- 1 x 900mm worktop



900 Layout

- 1 x 700 drawer unit
- 1 x link unit (left or right)
- 1 x 900mm worktop



1100 Layout

- 1 x 700 drawer unit
- 2 x link units (left, right or one each side)
- 1 x 1100mm worktop



1200 Layout

- 1 x 1000 drawer unit
- 1 x link unit (left or right)
- 1 x 1200mm worktop



1400 Layout

- 1 x 1000 drawer unit
- 2 x link units (left, right or one each side)
- 1 x 1400mm worktop

Modular storage to suit your needs

Glide II drawer units can be used alone or with our optional link units to create your personalised storage solution; with the wide choice of layout options it the perfect choice for any bathroom.

Glide II Carrara Marble Effect solid surface worktops are highly heat resistant, impenetrable to dust, dirt and bacteria and easy to clean. Simply drill on site for basin waste and tap fittings.

We have a wide choice of compatible basins to complete your bathroom, see page 92. Please note the basin must be positioned in the centre of the drawer unit.

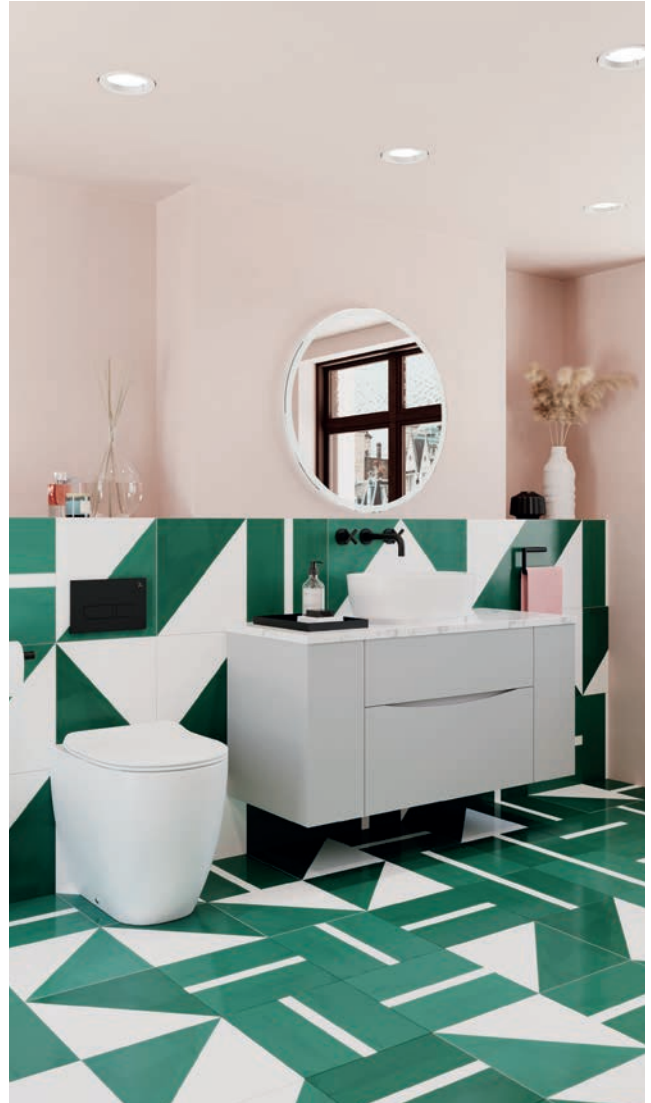

GLIDE II Wall Mounted Unit with Midnight Black Glass Basin

500

500 Double Drawer Unit
w 500 x d 450 x h 520mm (w/ basin 532mm)

500 1TH Midnight Black Glass Basin with Overflow
w 506 x d 450 x h 12mm

Steelwood



NEW

Unit **GL5000DST+** £780
Basin **GL0511SMB** £435
£1215

700

700 Double Drawer Unit
w 700 x d 450 x h 520mm (w/ basin 532mm)

700 1TH Midnight Black Glass Basin with Overflow
w 706 x d 455 x h 12mm



NEW

Unit **GL7000DST+** £865
Basin **GL0711SMB** £510
£1375

1000

1000 Double Drawer Unit
w 1000 x d 450 x h 520mm (w/ basin 532mm)

1000 1TH Midnight Black Glass Basin with Overflow
w 1006 x d 455 x h 12mm



NEW

Unit **GL1000DST+** £955
Basin **GL1011SMB** £755
£1710

Windsor Oak



NEW

Unit **GL5000DWO+** £715
Basin **GL0511SMB** £435
£1150



NEW

Unit **GL7000DWO+** £805
Basin **GL0711SMB** £510
£1315



NEW

Unit **GL1000DWO+** £870
Basin **GL1011SMB** £755
£1625

Matt Black



NEW

Unit **GL5000DBM+** £895
Basin **GL0511SMB** £435
£1330



NEW

Unit **GL7000DBM+** £955
Basin **GL0711SMB** £510
£1465



NEW

Unit **GL1000DBM+** £1095
Basin **GL1011SMB** £755
£1850

Storm Grey Matt



NEW

Unit **GL5000DSG+** £785
Basin **GL0511SMB** £435
£1220



NEW

Unit **GL7000DSG+** £865
Basin **GL0711SMB** £510
£1375



NEW

Unit **GL1000DSG+** £960
Basin **GL1011SMB** £755
£1715

White Gloss



NEW

Unit **GL5000DWG+** £730
Basin **GL0511SMB** £435
£1165



NEW

Unit **GL7000DWG+** £785
Basin **GL0711SMB** £510
£1295



NEW

Unit **GL1000DWG+** £870
Basin **GL1011SMB** £755
£1625

Alternative Basin - No Tap Hole

500 Basin with Overflow

w 506 x d 450 x h 12mm
For wall mounted taps

GL0510SMB £435

700 Basin with Overflow

w 706 x d 455 x h 12mm
For wall mounted taps

GL0710SMB £510

1000 Basin with Overflow

w 1006 x d 455 x h 12mm
For wall mounted taps

GL1010SMB £755

Trap Fittings

Short Furniture Trap

Height adjustable. 40.6L/min flow rate
Fits 32-43mm waste pipe. 50mm water seal

BTR0510W £30



Glide II glass basins are handcast from low iron soda lime silicate glass. Each basin conforms to EN572-9:2005 and EN 14688:2009. Maximum water temperature 70 °C



GLIDE II Wall Mounted Unit with Ice White Glass Basin

500

500 Double Drawer Unit
w 500 x d 450 x h 520mm (w/ basin 532mm)

500 1TH Ice White Glass Basin with Overflow
w 506 x d 450 x h 12mm

Steelwood



NEW

Unit **GL5000DST+** £780
Basin **GL0511SIW+** £380
£1160

Windsor Oak



Unit **GL5000DWO+** £715
Basin **GL0511SIW+** £380
£1095

Matt Black



NEW

Unit **GL5000DBM+** £895
Basin **GL0511SIW+** £380
£1275

Storm Grey Matt



Unit **GL5000DSG+** £785
Basin **GL0511SIW+** £380
£1165

White Gloss



Unit **GL5000DWG+** £730
Basin **GL0511SIW+** £380
£1110

700

700 Double Drawer Unit
w 700 x d 450 x h 520mm (w/ basin 532mm)

700 1TH Ice White Glass Basin with Overflow
w 706 x d 455 x h 12mm



NEW

Unit **GL7000DST+** £865
Basin **GL0711SIW+** £480
£1345



Unit **GL7000DWO+** £805
Basin **GL0711SIW+** £480
£1285



NEW

Unit **GL7000DBM+** £955
Basin **GL0711SIW+** £480
£1435



Unit **GL7000DSG+** £865
Basin **GL0711SIW+** £480
£1345



Unit **GL7000DWG+** £785
Basin **GL0711SIW+** £480
£1265

1000

1000 Double Drawer Unit
w 1000 x d 450 x h 520mm (w/ basin 532mm)

1000 1TH Ice White Glass Basin with Overflow
w 1006 x d 455 x h 12mm



NEW

Unit **GL1000DST+** £955
Basin **GL1011SIW** £670
£1625



Unit **GL1000DWO+** £870
Basin **GL1011SIW** £670
£1540



NEW

Unit **GL1000DBM+** £1095
Basin **GL1011SIW** £670
£1765



Unit **GL1000DSG+** £960
Basin **GL1011SIW** £670
£1630



Unit **GL1000DWG+** £870
Basin **GL1011SIW** £670
£1540

Alternative Basin - No Tap Hole

500 Basin with Overflow

w 506 x d 450 x h 12mm
For wall mounted taps

GL0510SIW+ £380

700 Basin with Overflow

w 706 x d 455 x h 12mm
For wall mounted taps

GL0710SIW+ £480

1000 Basin with Overflow

w 1006 x d 455 x h 12mm
For wall mounted taps

GL1010SIW £665

Trap Fittings

Short Furniture Trap

Height adjustable. 40.L/min flow rate
Fits 32-43mm waste pipe. 50mm water seal

BTR0510W £30



Glide II glass basins are handcast from low iron soda lime silicate glass. Each basin conforms to EN572-9:2005 and EN 14688:2009. Maximum water temperature 70 °C



GLIDE II Wall Mounted Unit with Cast Mineral Marble Basin

500

500 Double Drawer Unit
w 500 x d 450 x h 520mm (w/ basin 600mm)

500 1TH Cast Mineral Marble Basin with Overflow
w 500 x d 450 x h 80mm

Steelwood



NEW

Unit **GL5000DST+** £780
Basin **DE0002SRW+** £320
£1100

Windsor Oak



Unit **GL5000DWO+** £715
Basin **DE0002SRW+** £320
£1035

Matt Black



NEW

Unit **GL5000DBM+** £895
Basin **DE0002SRW+** £320
£1215

Storm Grey Matt



Unit **GL5000DSG+** £785
Basin **DE0002SRW+** £320
£1105

White Gloss



Unit **GL5000DWG+** £730
Basin **DE0002SRW+** £320
£1050

700

700 Double Drawer Unit
w 700 x d 450 x h 520mm (w/ basin 600mm)

700 1TH Cast Mineral Marble Basin with Overflow
w 700 x d 450 x h 80mm



NEW

Unit **GL7000DST+** £865
Basin **DE0003SRW+** £425
£1290



Unit **GL7000DWO+** £805
Basin **DE0003SRW+** £425
£1230



NEW

Unit **GL7000DBM+** £955
Basin **DE0003SRW+** £425
£1380



Unit **GL7000DSG+** £865
Basin **DE0003SRW+** £425
£1290



Unit **GL7000DWG+** £785
Basin **DE0003SRW+** £425
£1210

1000

1000 Double Drawer Unit
w 1000 x d 450 x h 520mm (w/ basin 600mm)

1000 Cast Mineral Marble Basin with Overflow
Available as 1 or 2 tap hole
w 1000 x d 450 x h 80mm



NEW

Unit **GL1000DST+** £955
1TH Basin **DE0004SRW+** £520
2TH Basin **DE0040SRW+** £520
£1475



Unit **GL1000DWO+** £870
1TH Basin **DE0004SRW+** £520
2TH Basin **DE0040SRW+** £520
£1390



NEW

Unit **GL1000DBM+** £1095
1TH Basin **DE0004SRW+** £520
2TH Basin **DE0040SRW+** £520
£1615



Unit **GL1000DSG+** £960
1TH Basin **DE0004SRW+** £520
2TH Basin **DE0040SRW+** £520
£1480



Unit **GL1000DWG+** £870
1TH Basin **DE0004SRW+** £520
2TH Basin **DE0040SRW+** £520
£1390

Alternative Basin - No Tap Hole

500 Basin with Overflow

w 500 x d 450 x h 80mm
For wall mounted taps

DE0510SRW+ £320

700 Basin with Overflow

w 700 x d 455 x h 80mm
For wall mounted taps

DE0710SRW+ £425

1000 Basin with Overflow

w 1000 x d 455 x h 80mm
For wall mounted taps

DE1010SRW+ £530

Trap Fittings

Furniture Basin Trap













We recommend using this trap to ensure full use of drawers

BTR0410W £45





Due to ceramic manufacturing processes all dimensions printed are approximate.



GLIDE II Wall Mounted Unit with Ceramic Basin

500		700		1000	
500 Double Drawer Unit w 500 x d 450 x h 520mm (w/ basin 540mm)		700 Double Drawer Unit w 700 x d 450 x h 520mm (w/ basin 540mm)		1000 Double Drawer Unit w 1000 x d 450 x h 520mm (w/ basin 540mm)	
500 1TH White Vitreous China Basin with Overflow w 510 x d 460 x h 20mm		700 1TH White Vitreous China Basin with Overflow w 710 x d 460 x h 20mm		1000 1TH White Vitreous China Basin with Overflow w 1010 x d 460 x h 20mm	
Steelwood					
NEW		NEW		NEW	
Unit GL5000DST+	£780	Unit GL7000DST+	£865	Unit GL1000DST+	£955
Basin DE0002SCW+	£190	Basin DE0003SCW+	£420	Basin DE0004SCW+	£520
£970		£1285		£1475	
Windsor Oak					
					
Unit GL5000DWO+	£715	Unit GL7000DWO+	£805	Unit GL1000DWO+	£870
Basin DE0002SCW+	£190	Basin DE0003SCW+	£420	Basin DE0004SCW+	£520
£905		£1225		£1390	
Matt Black					
NEW		NEW		NEW	
Unit GL5000DBM+	£895	Unit GL7000DBM+	£955	Unit GL1000DBM+	£1095
Basin DE0002SCW+	£190	Basin DE0003SCW+	£420	Basin DE0004SCW+	£520
£1085		£1375		£1615	
Storm Grey Matt					
					
Unit GL5000DSG+	£785	Unit GL7000DSG+	£865	Unit GL1000DSG+	£960
Basin DE0002SCW+	£190	Basin DE0003SCW+	£420	Basin DE0004SCW+	£520
£975		£1285		£1480	
White Gloss					
					
Unit GL5000DWG+	£730	Unit GL7000DWG+	£785	Unit GL1000DWG+	£870
Basin DE0002SCW+	£190	Basin DE0003SCW+	£420	Basin DE0004SCW+	£520
£920		£1205		£1390	

Optional Overflow Cover

			
Chrome	Matt Black	Brushed Brass	Brushed Stainless Steel Effect
Chrome plated brass	Epoxy coated steel	PVD brass	PVD brass
OVFLOWC	OVFLOWMB	OVFLOWF	OVFLOWV
£15	£15	£15	£15

Due to ceramic manufacturing processes all dimensions printed are approximate.



Glide II Ceramic Basins sit flush to the drawer with a useful area to the side for storing your bathroom essentials. Add an optional overflow cover to match your brassware for a fully cohesive look.



GLIDE II

Wall Hung Tower Unit

Two doors with soft close. Reversible left/right hand opening. 5 fixed height shelves.



NEW

Steelwood

w 350 x d 350 x h 1600mm

GL3516FST+ £855



Windsor Oak

w 350 x d 350 x h 1600mm

GL3516FWO+ £855



NEW

Matt Black

w 350 x d 350 x h 1600mm

GL3516FBM+ £855



Storm Grey Matt

w 350 x d 350 x h 1600mm

GL3516FSG+ £855



White Gloss

w 350 x d 350 x h 1600mm

GL3516FWG+ £855

Toilet Furniture Units

Uncut fascia with removable top and adjustable feet. Suitable for toilet frame WCF82X50+ and concealed cisterns WCC47X46+2 or WCC33X31+. Requires assembly before installation.



NEW

Steelwood

w 545 x d 225 x h 920mm

SP5492ST+ £230



Windsor Oak

w 545 x d 225 x h 920mm

SP5492WO £305



NEW

Matt Black

w 545 x d 225 x h 920mm

SP5492BM £255



Storm Grey Matt

w 545 x d 225 x h 920mm

SP5492SG £255



White Gloss

w 545 x d 225 x h 920mm

SP5492WG £270

Trap Fittings



Short Furniture Trap

Height adjustable. 40.6L/min flow rate
Fits 32-43mm waste pipe
50mm water seal
Conforms to BS EN 274-1:2002

BTR0510W

£30



Furniture Basin Trap

Extra slim push-fit trap. Fits 1¼" waste pipe.
Horizontal or vertical installation
Min height under basin: 54mm
Anti-back siphoning

BTR0410W

£45





NEW





ARENA

Arena uses state of the art manufacturing technology and the essential elements of traditional Scandinavian design to deliver a furniture range that excels in both form and function with a focus on slender space saving proportions, ample storage and clean simple lines.

With a choice of Vanity or Console units this range is perfect for any bathroom.



10 Year Guarantee*
Peace of mind



Console with worktop p 42

Vanity with worktop p 44

Console with basin p 46

Vanity with basin p 48

Toilet furniture units p 50



ARENA

Product Highlights

1. Soft close, pull to open, full extension drawers with 2 way adjustment (30kg weight capacity)
2. Plywood style decor drawer edging, hand finished using PU adhesives
3. Wall hangers with 3 way adjustment and safety lock (180kg weight capacity when fitted to solid wall)
4. Drawer cut out for services

Finishes

All our finishes are designed to be visually striking whilst offering high levels of durability. They are manufactured from 80% renewable sources.



Steelwood

Authentic wood effect
Matching edging
PU
Antibacterial*



Modern Oak

Authentic wood effect
Matching edging
PU
Antibacterial*



Portland Grey Matt

Laminate finish
PU
Antibacterial
Anti fingerprint



Pure White Gloss

Laminate finish
PU
Antibacterial

Handles



Chrome



Matt Black



Brushed Brass



Brushed Stainless Steel

Effect

Worktops

All worktops are produced from 18mm thick, high density core board. The surfaces are resistant to day to day wear and tear, impact, scratching and normal household cleaning agents. White and grey worktops are slightly matt with a subtle texture. The Pure white Gloss edging matches the furniture carcass. All worktop tops have a factory fitted aluminium reinforcing bar on the underside.



Steelwood

Supplied undrilled



Modern Oak

Supplied undrilled



Portland Grey Matt

Supplied undrilled



Pure White Gloss

Supplied undrilled

Basin



Ceramic

White fine fire clay

Overflow colour options available see p 105

* tested according to JIS Z 2801/ISO22196



ARENA Wall Mounted Console Unit with Worktop

600

600 Single Drawer Console Unit
w 605 x d 375 x h 320mm (w/ top 338mm)

610 Worktop

w 610 x d 380 x h 18mm

Steelwood



NEW

Unit	AN6032DST+	£460
Worktop	AN6100TST+	£120
		£580

700

700 Single Drawer Console Unit
w 705 x d 375 x h 320mm (w/ top 338mm)

710 Worktop

w 710 x d 380 x h 18mm



NEW

Unit	AN7032DST+	£510
Worktop	AN7100TST+	£150
		£660

1000

1000 Single Drawer Console Unit
w 1054 x d 375 x h 320mm (w/ top 338mm)

1010 Worktop

w 1010 x d 380 x h 18mm



NEW

Unit	AN10032DST+	£585
Worktop	AN1010TST+	£170
		£755

Modern Oak



NEW

Unit	AN6032DMO	£445
Worktop	AN6100TMO	£120
		£565



NEW

Unit	AN7032DMO	£490
Worktop	AN7100TMO	£150
		£640



NEW

Unit	AN10032DMO	£570
Worktop	AN1010TMO	£170
		£740

Portland Grey Matt



NEW

Unit	AN6032DPGM	£515
Worktop	AN6100TPGM	£140
		£655



NEW

Unit	AN7032DPGM	£540
Worktop	AN7100TPGM	£160
		£700



NEW

Unit	AN10032DPGM	£630
Worktop	AN1010TPGM	£190
		£820

Pure White Gloss



NEW

Unit	AN6032DPWG	£515
Worktop	AN6100TPWG	£140
		£655



NEW

Unit	AN7032DPWG	£540
Worktop	AN7100TPWG	£160
		£700



NEW

Unit	AN10032DPWG	£630
Worktop	AN1010TPWG	£190
		£820

Handle Options must be ordered separately

Please note: drawers are pilot drilled for our handles.



Chrome

Chrome plated aluminium

IF_HANDLEC £40



Matt Black

Epoxy coated aluminium

IF_HANDLEBM £40



Brushed Brass

Anodised aluminium

IF_HANDLEF £45



Brushed Stainless Steel Effect

Anodised aluminium

IF_HANDLEV £45

Recommended Basins see page 92 for our full list of compatible basins



Pearl Matt White PLUS+TON®

w 450 x d 350 x h 158mm

CT05823SCWM £670



Alice

w 560 x d 327 x h 187mm

CT5637URW £590



NEW

Navona

w 450 x d 350 x h 120mm

CT08801SCW £400



Castellon Mini

w 350 x d 350 x h 140mm

CT4015SCW £175

Choose your countertop basin

The above are a small selection of our countertop basins available, see page 92 for our full range of compatible basins.



Arena worktops are resistant to day to day wear and tear, impact, scratching and normal household cleaning agents. Simply drill on site for basin waste and tap fittings.



All Arena furniture units have been designed with the details in mind, the plywood style decor edging and classic birchwood drawer finish adds a touch of luxury to any bathroom.



ARENA Wall Mounted Unit with Worktop

600

600 Single Drawer Unit
w 605 x d 375 x h 450mm (w/ top 468mm)

610 Worktop
w 610 x d 380 x h 18mm

Steelwood



NEW			
Unit	AN6000DST+	£470	
Worktop	AN6100TST+	£120	
		£590	

700

700 Single Drawer Unit
w 705 x d 375 x h 450mm (w/ top 468mm)

710 Worktop
w 710 x d 380 x h 18mm



NEW			
Unit	AN7000DST+	£540	
Worktop	AN7100TST+	£150	
		£690	

1000 LH

1000 Double Drawer Unit LH
w 1054 x d 375 x h 450mm (w/ top 468mm)

1010 Worktop
w 1010 x d 380 x h 18mm



NEW			
Unit	AN1000DST_LH+	£690	
Worktop	AN1010TST+	£170	
		£860	

1000 RH

1000 Double Drawer Unit RH
w 1054 x d 375 x h 450mm (w/ top 468mm)

1010 Worktop
w 1010 x d 380 x h 18mm



NEW			
Unit	AN1000DST_RH+	£690	
Worktop	AN1010TST+	£170	
		£860	

Modern Oak



NEW			
Unit	AN6000DMO	£460	
Worktop	AN6100TMO	£120	
		£580	



NEW			
Unit	AN7000DMO	£540	
Basin	AN7100TMO	£150	
		£690	



NEW			
Unit	AN1000DMO_LH	£690	
Worktop	AN1010TMO	£170	
		£860	



NEW			
Unit	AN1000DMO_RH	£690	
Worktop	AN1010TMO	£170	
		£860	

Portland Grey Matt



NEW			
Unit	AN6000DPGM	£550	
Worktop	AN6100TPGM	£140	
		£690	



NEW			
Unit	AN7000DPGM	£590	
Worktop	AN7100TPGM	£160	
		£750	



NEW			
Unit	AN1000DPGM_LH	£790	
Worktop	AN1010TPGM	£190	
		£980	



NEW			
Unit	AN1000DPGM_RH	£790	
Worktop	AN1010TPGM	£190	
		£980	

Pure White Gloss



NEW			
Unit	AN6000DPWG	£540	
Worktop	AN6100TPWG	£140	
		£680	



NEW			
Unit	AN7000DPWG	£590	
Worktop	AN7100TPWG	£160	
		£750	



NEW			
Unit	AN1000DPWG_LH	£790	
Worktop	AN1010TPWG	£190	
		£980	



NEW			
Unit	AN1000DPWG_RH	£790	
Worktop	AN1010TPWG	£190	
		£980	

Handle Options must be ordered separately

Please note: drawer fronts are pilot drilled for our handles.



Chrome		
Chrome plated aluminium		
IF_HANDLEC	£40	



Matt Black		
Epoxy coated aluminium		
IF_HANDLEBM	£40	



Brushed Brass		
Anodised aluminium		
IF_HANDLEF	£45	



Brushed Stainless Steel Effect		
Anodised aluminium		
IF_HANDLEV	£45	

Recommended Basins see page 92 for our full list of compatible basins



Pearl Matt White PLUS+TON®	
w 450 x d 350 x h 158mm	
CT05823SCWM	£670



Alice	
w 560 x d 327 x h 187mm	
CT5637URW	£590



NEW	
Navona	
w 450 x d 350 x h 120mm	
CT08801SCW	£400



Castellon Mini	
w 350 x d 350 x h 140mm	
CT4015SCW	£175



All Arena furniture units have been designed with the details in mind, the plywood style decor edging and classic birchwood drawer finish adds a touch of luxury to any bathroom.



ARENA Wall Mounted Console Unit with Fine Fire Clay Basin

600

600 Single Drawer Console Unit
w 605 x d 375 x h 320mm (w/ basin 355mm)

650 1TH Basin with Overflow
w 650 x d 375/402 x h 35mm

Steelwood



NEW

Unit **AN6032DST+** £460
Basin **AN0611SCW** £360
£820

700

700 Single Drawer Console Unit
w 705 x d 375 x h 320mm (w/ basin 355mm)

750 1TH Basin with Overflow
w 750 x d 375/402 x h 35mm



NEW

Unit **AN7032DST+** £510
Basin **AN0711SCW** £380
£890

1000 LH

1000 Single Drawer Console Unit
w 1054 x d 375 x h 320mm (w/ basin 355mm)

1100 1TH Basin with Overflow LH
w 1100 x d 375/402 x h 35mm



NEW

Unit **AN10032DST** £585
Basin **AN1011SCW_LH** £560
£1145

1000 RH

1000 Single Drawer Console Unit
w 1054 x d 375 x h 320mm (w/ basin 355mm)

1100 1TH Basin with Overflow RH
w 1100 x d 375/402 x h 35mm



NEW

Unit **AN10032DST** £585
Basin **AN1011SCW_RH** £560
£1145

Modern Oak



Unit **AN6032DMO** £445
Basin **AN0611SCW** £360
£805



Unit **AN7032DMO** £490
Basin **AN0711SCW** £380
£870



Unit **AN10032DMO** £570
Basin **AN1011SCW_LH** £560
£1130



Unit **AN10032DMO** £570
Basin **AN1011SCW_RH** £560
£1130

Portland Grey Matt



Unit **AN6032DPGM** £515
Basin **AN0611SCW** £360
£875



Unit **AN7032DPGM** £540
Basin **AN0711SCW** £380
£920



Unit **AN10032DPGM** £630
Basin **AN1011SCW_LH** £560
£1190



Unit **AN10032DPGM** £630
Basin **AN1011SCW_RH** £560
£1190

Pure White Gloss



Unit **AN6032DPWG** £515
Basin **AN0611SCW** £360
£875



Unit **AN7032DPWG** £540
Basin **AN0711SCW** £380
£920



Unit **AN10032DPWG** £630
Basin **AN1011SCW_LH** £560
£1190



Unit **AN10032DPWG** £630
Basin **AN1011SCW_RH** £560
£1190

Handle Options must be ordered separately

Please note: drawer fronts are pilot drilled for our handles.



Chrome

Chrome plated aluminium

IF_HANDLEC £40



Matt Black

Epoxy coated aluminium

IF_HANDLEBM £40



Brushed Brass

Anodised aluminium

IF_HANDLEF £45



Brushed Stainless Steel Effect

Anodised aluminium

IF_HANDLEV £45

Alternative Basin - No Tap Hole

650 Basin with Overflow
w 650 x d 375/402 x h 35mm

AN0610SCW £415

750 Basin with Overflow
w 750 x d 375/402 x h 35mm

AN0710SCW £435

1100 Basin with Overflow LH
w 1100 x d 375/402 x h 35mm

AN1010SCW_LH £580

1100 Basin with Overflow RH
w 1100 x d 375/402 x h 35mm

AN1010SCW_RH £580

Required Basin Waste

Ceramic Click Clack Basin Waste

Gloss white ceramic to match basin
This waste is required for all Arena basins

BSW0103GW+ £95

Trap Fittings

Short Furniture Trap

Height adjustable. 40.6L/min flow rate
Fits 32-43mm waste pipe, 50mm water seal

BTR0510W £30

Complete Your Fully Co-ordinating Bathroom

We have everything you need to complete your perfect bathroom; from taps to shower heads in perfectly matching MPRO finishes. To see our full range of brassware please visit crosswater.co.uk



All Arena furniture units have been designed with the details in mind, the plywood style decor edging and classic birchwood drawer finish adds a touch of luxury to any bathroom.



ARENA Wall Mounted Unit with Fine Fire Clay Basin

600

600 Single Drawer Unit
w 605 x d 375 x h 450mm (w/ basin 485mm)

650 1TH Basin with Overflow
w 650 x d 375/402 x h 35mm

Steelwood



NEW
Unit **AN6000DST+** £470
Basin **AN0611SCW** £360
£830

700

700 Single Drawer Unit
w 705 x d 375 x h 450mm (w/ basin 485mm)

750 1TH Basin with Overflow
w 750 x d 375/402 x h 35mm



NEW
Unit **AN7000DST+** £540
Basin **AN0711SCW** £380
£920

1000 LH

1000 Double Drawer Unit LH
w 1054 x d 375 x h 450mm (w/ basin 485mm)

1100 1TH Basin with Overflow LH
w 1100 x d 375/402 x h 35mm



NEW
Unit **AN1000DST_LH+** £690
Basin **AN1011SCW_LH** £560
£1250

1000 RH

1000 Double Drawer Unit RH
w 1054 x d 375 x h 450mm (w/ basin 485mm)

1100 1TH Basin with Overflow RH
w 1100 x d 375/402 x h 35mm



NEW
Unit **AN1000DST_RH+** £690
Basin **AN1011SCW_RH** £560
£1250

Modern Oak



Unit **AN6000DMO** £460
Basin **AN0611SCW** £360
£820



Unit **AN7000DMO** £540
Basin **AN0711SCW** £380
£920



Unit **AN1000DMO_LH** £690
Basin **AN1011SCW_LH** £560
£1250



Unit **AN1000DMO_RH** £690
Basin **AN1011SCW_RH** £560
£1250

Portland Grey Matt



Unit **AN6000DPGM** £550
Basin **AN0611SCW** £360
£910



Unit **AN7000DPGM** £590
Basin **AN0711SCW** £380
£970



Unit **AN1000DPGM_LH** £790
Basin **AN1011SCW_LH** £560
£1350



Unit **AN1000DPGM_RH** £790
Basin **AN1011SCW_RH** £560
£1350

Pure White Gloss



Unit **AN6000DPWG** £540
Basin **AN0611SCW** £360
£900



Unit **AN7000DPWG** £590
Basin **AN0711SCW** £380
£970



Unit **AN1000DPWG_LH** £790
Basin **AN1011SCW_LH** £560
£1350



Unit **AN1000DPWG_RH** £790
Basin **AN1011SCW_RH** £560
£1350

Handle Options must be ordered separately

Please note: drawer fronts are pilot drilled for our handles.



Chrome

Chrome plated aluminium

IF_HANDLEC £40



Matt Black

Epoxy coated aluminium

IF_HANDLEBM £40



Brushed Brass

Anodised aluminium

IF_HANDLEF £45



Brushed Stainless Steel Effect

Anodised aluminium

IF_HANDLEV £45

Alternative Basin - No Tap Hole

650 Basin with Overflow

w 650 x d 375/402 x h 35mm

AN0610SCW £415

750 Basin with Overflow

w 750 x d 375/402 x h 35mm

AN0710SCW £435

1100 Basin with Overflow LH

w 1100 x d 375/402 x h 35mm

AN1010SCW_LH £580

1100 Basin with Overflow RH

w 1100 x d 375/402 x h 35mm

AN1010SCW_RH £580

Required Basin Waste

Ceramic Click Clack Basin Waste

Gloss white ceramic to match basin
This waste is required for all Arena basins

BSW0103GW+ £95

Trap Fittings

Short Furniture Trap

Height adjustable. 40.6L/min flow rate
Fits 32-43mm waste pipe. 50mm water seal

BTR0510W £30

Complete Your Fully Co-ordinating Bathroom

We have everything you need to complete your perfect bathroom; from taps to shower heads in perfectly matching MPRO finishes. To see our full range of brassware please visit crosswater.co.uk



All Arena furniture units have been designed with the details in mind, the plywood style decor edging and classic birchwood drawer finish adds a touch of luxury to any bathroom.



ARENA

Toilet Furniture Units

Uncut fascia with removable top and adjustable feet. Suitable for toilet frame WCF82X50+ and concealed cisterns WCC47X46+2 or WCC33X31+. Requires assembly before installation.



NEW

Steelwood

w 545 x d 225 x h 920mm

SP5492ST+

£230



Modern Oak

w 545 x d 225 x h 920mm

SP5492MO

£245



Portland Grey Matt

w 545 x d 225 x h 920mm

SP5492PGM

£360



Pure White Gloss

w 545 x d 225 x h 920mm

SP5492WG+

£365

Optional Overflow Cover



Chrome

Chrome plated brass

OVFLOWC

£15



Matt Black

Epoxy coated steel

OVFLOWMB

£15



Brushed Brass

PVD brass

OVFLOWB

£15



Brushed Stainless Steel Effect

PVD brass

OVFLOWV

£15

Basin Waste



Ceramic Click Clack Basin Waste

Gloss white ceramic to match basin
This waste is required for all Arena basins

BSW0103GW+

£95

Trap Fittings



Short Furniture Trap

Height adjustable. 40.6L/min flow rate
Fits 32-43mm waste pipe
50mm water seal
Conforms to BS EN 274-1:2002

BTR0510W

£30



Furniture Basin Trap

Extra slim push-fit trap. Fits 1 1/4" waste pipe.
Horizontal or vertical installation
Min height under basin: 54mm
Anti-back siphoning

BTR0410W

£45



All Arena furniture units have been designed with the details in mind, the plywood style decor edging and classic birchwood drawer finish adds a touch of luxury to any bathroom.



NEW





SVELTE

Combining handcrafted sweeping curves, elegant finishes and handleless design.

Our Svelte furniture is a sleek, beautifully versatile range that will suit any bathroom no matter your layout.



10 Year Guarantee*
Peace of mind



Carrara marble effect worktop p 56

Glass basin p 58

Cast mineral marble basin p 60

Toilet furniture units p 62



SVELTE

Product Highlights

1. Fully assembled
2. 18mm carcasses and handcrafted drawer fronts
3. Soft close, pull to open, full extension drawers with 2 way adjustment (30kg weight capacity)
4. Wall hangers with 2 way adjustment and safety lock (120kg weight capacity when fitted to solid wall)
5. Top drawer cut out for services

Finishes

All Crosswater real wood veneer finishes are produced from sustainable forestry projects. 85% of the boards are produced from recyclable materials.



Castilla Oak

Real wood veneer
Matching edging
PU
Anti UV matt varnish



American Walnut

Real wood veneer
Matching edging
PU
Anti UV matt varnish



Grey Ash

Real wood veneer
Matching edging
PU
Anti UV matt varnish



Storm Grey Matt

Lacquered finish
ACTIVE antibacterial
Anti fingerprint



White Gloss

Lacquered finish
ACTIVE antibacterial

Basins



Ice White Glass

Handcast from low iron soda silicate glass
External overflow with chrome cover
Hand polished gloss finish
Antibacterial



Cast Mineral Marble

High gloss white
External overflow with chrome cover

Worktop

Our solid surface worktops are highly heat resistant, impenetrable to dust, dirt and bacteria making them easy to clean.



Carrara Marble Effect

Easy clean solid surface
Supplied undrilled



SVELTE Wall Mounted Unit with Carrara Marble Effect Worktop

600

600 Double Drawer Unit
w 595 x d 453 x h 520mm (w/ top 545mm)

600 Worktop
w 604 x d 457 x h 25mm

Castilla Oak



NEW			
Unit	SE6000DCO	£1150	
Worktop	SE6000TMC	£800	
		£1950	

American Walnut



NEW			
Unit	SE6000DAW	£1115	
Worktop	SE6000TMC	£800	
		£1915	

Grey Ash



NEW			
Unit	SE6000DGA	£1115	
Worktop	SE6000TMC	£800	
		£1915	

Storm Grey Matt



NEW			
Unit	SE6000DSG	£1070	
Worktop	SE6000TMC	£800	
		£1870	

White Gloss



NEW			
Unit	SE6000DWG	£1015	
Worktop	SE6000TMC	£800	
		£1815	

800

800 Double Drawer Unit
w 795 x d 447 x h 520mm (w/ top 545mm)

800 Worktop
w 806 x d 445 x h 25mm



NEW			
Unit	SE8000DCO	£1270	
Worktop	SE8000TMC	£915	
		£2185	



NEW			
Unit	SE8000DAW	£1195	
Worktop	SE8000TMC	£915	
		£2110	



NEW			
Unit	SE8000DGA	£1195	
Worktop	SE8000TMC	£915	
		£2110	



NEW			
Unit	SE8000DSG	£1155	
Worktop	SE8000TMC	£915	
		£2070	



NEW			
Unit	SE8000DWG	£1070	
Worktop	SE8000TMC	£915	
		£1985	

1000

1000 Double Drawer Unit
w 1000 x d 460 x h 520mm (w/ top 545mm)

1000 Worktop
w 1012 x d 465/411 x h 25mm



NEW			
Unit	SE1000SDCO+	£1565	
Worktop	SE1000STMC	£920	
		£2485	



NEW			
Unit	SE1000SDAW+	£1435	
Worktop	SE1000STMC	£920	
		£2355	



NEW			
Unit	SE1000SDGA+	£1460	
Worktop	SE1000STMC	£920	
		£2380	



NEW			
Unit	SE1000SDSG+	£1420	
Worktop	SE1000STMC	£920	
		£2340	



NEW			
Unit	SE1000SDWG+	£1345	
Worktop	SE1000STMC	£920	
		£2265	

Trap Fittings

Furniture Basin Trap

We recommend using this trap to ensure full use of drawers

BTR0410W **£45**

Choose your countertop basin

We have a wide choice of countertop basins available to perfectly complement the distinctive curves of Svelte's drawer units.

Please see page 92 for our compatible basins.



Svelte Carrara Marble Effect solid surface worktops are highly heat resistant, impenetrable to dust, dirt and bacteria and easy to clean. Simply drill on site for basin waste and tap fittings.



SVELTE Wall Mounted Unit with Ice White Glass Basin

600

600 Double Drawer Unit
w 595 x d 453 x h 520mm (w/ basin 540mm)

600 1TH Ice White Glass Basin with Overflow
w 600 x d 457 x h 20mm

Castilla Oak



NEW

Unit **SE6000DCO** £1150
Basin **SE0611SICE** £470
£1620

American Walnut



Unit **SE6000DAW** £1115
Basin **SE0611SICE** £470
£1585

Grey Ash



Unit **SE6000DGA** £1115
Basin **SE0611SICE** £470
£1585

Storm Grey Matt



Unit **SE6000DSG** £1070
Basin **SE0611SICE** £470
£1540

White Gloss



Unit **SE6000DWG** £1015
Basin **SE0611SICE** £470
£1485

800

800 Double Drawer Unit
w 795 x d 447 x h 520mm (w/ basin 540mm)

800 1TH Ice White Glass Basin with Overflow
w 800 x d 457 x h 20mm



NEW

Unit **SE8000DCO** £1270
Basin **SE0811SICE** £525
£1795



Unit **SE8000DAW** £1195
Basin **SE0811SICE** £525
£1720



Unit **SE8000DGA** £1195
Basin **SE0811SICE** £525
£1720



Unit **SE8000DSG** £1155
Basin **SE0811SICE** £525
£1680



Unit **SE8000DWG** £1070
Basin **SE0811SICE** £525
£1595

1000

1000 Double Drawer Unit
w 1000 x d 460 x h 520mm (w/ basin 540mm)

1000 1TH Ice White Glass Basin with Overflow
w 1010 x d 471/415 x h 20mm



NEW

Unit **SE1000SDCO+** £1565
Basin **SE1011SSICE** £715
£2280



Unit **SE1000SDAW+** £1435
Basin **SE1011SSICE** £715
£2150



Unit **SE1000SDGA+** £1460
Basin **SE1011SSICE** £715
£2175



Unit **SE1000SDSG+** £1420
Basin **SE1011SSICE** £715
£2135



Unit **SE1000SDWG+** £1345
Basin **SE1011SSICE** £715
£2060

Trap Fittings

Furniture Basin Trap

We recommend using this trap to ensure full use of drawers















BTR0410W £45

Glass basins

Svelte glass basins are handcast from low iron soda lime silicate glass. Each basin is impervious and conforms to EN572-9:2005 and EN 14688:2009. Maximum water temperature 70 °C



SVELTE Wall Mounted Unit with White Durocoat® Cast Mineral Marble Basin

600		800		1000	
600 Double Drawer Unit w 595 x d 453 x h 520mm (w/ basin 540mm)		800 Double Drawer Unit w 795 x d 447 x h 520mm (w/ basin 540mm)		1000 Double Drawer Unit w 1000 x d 460 x h 520mm (w/ basin 540mm)	
600 1TH Cast Mineral Marble Basin with Overflow w 600 x d 457 x h 20mm		800 1TH Cast Mineral Marble Basin with Overflow w 800 x d 450 x h 20mm		1000 1TH Cast Mineral Marble Basin with Overflow w 1006 x d 471/415 x h 20mm	
Castilla Oak					
					
NEW Unit SE6000DCO £1150 Basin SE0611SRW+ £350 £1500	NEW Unit SE8000DCO £1270 Basin SE0811SRW+ £380 £1650	NEW Unit SE1000SDCO+ £1565 Basin SE1011SSRW+2 £420 £1985			
American Walnut					
					
Unit SE6000DAW £1115 Basin SE0611SRW+ £350 £1465	Unit SE8000DAW £1195 Basin SE0811SRW+ £380 £1575	Unit SE1000SDAW+ £1435 Basin SE1011SSRW+2 £420 £1855			
Grey Ash					
					
Unit SE6000DGA £1115 Basin SE0611SRW+ £350 £1465	Unit SE8000DGA £1195 Basin SE0811SRW+ £380 £1575	Unit SE1000SDGA+ £1460 Basin SE1011SSRW+2 £420 £1880			
Storm Grey Matt					
					
Unit SE6000DSG £1070 Basin SE0611SRW+ £350 £1420	Unit SE8000DSG £1155 Basin SE0811SRW+ £380 £1535	Unit SE1000SDSG+ £1420 Basin SE1011SSRW+2 £420 £1840			
White Gloss					
					
Unit SE6000DWG £1015 Basin SE0611SRW+ £350 £1365	Unit SE8000DWG £1070 Basin SE0811SRW+ £380 £1450	Unit SE1000SDWG+ £1345 Basin SE1011SSRW+2 £420 £1765			

Trap Fittings

Furniture Basin Trap

We recommend using this trap to ensure full use of drawers

BTR0410W £45



Toilet Furniture Units

Uncut fascia with removable top and adjustable feet. Suitable for toilet frame WCF82X50+ and concealed cisterns WCC47X46+2 or WCC33X31+. Requires assembly before installation.



NEW
Castilla Oak

w 545 x d 225 x h 920mm

SP5492CO £305



American Walnut

w 545 x d 225 x h 920mm

SP5492AW £305



Grey Ash

w 545 x d 225 x h 920mm

SP5492GA £305



Storm Grey Matt

w 545 x d 225 x h 920mm

SP5492SG £255



White Gloss

w 545 x d 225 x h 920mm

SP5492WG £270

Trap Fittings



Furniture Basin Trap

Extra slim push-fit trap. Fits 1¼" waste pipe.
Horizontal or vertical installation
Min height under basin: 54mm
Anti-back siphoning

BTR0410W £45

Real wood veneer

All our real wood veneer finishes are book matched and produced from sustainable sources. The characteristic nature of natural veneers means there will be variance in tone, grain and colour, this is just part of the enduring beauty of wood veneer furniture.

When ordering more than one unit we recommend taking delivery of products at the same time.





NEW





INFINITY

Taking bathroom furniture to another level. Infinity is simplicity in its finest form. A smart, modular wall hung storage furniture collection that allows you to specify layouts from 500 to 1400mm wide with only 3 basic parts.



10 Year Guarantee*
Peace of mind



Modular units p 70
Toilet furniture units p 72



INFINITY

Product Highlights

1. Fully assembled
2. Soft close, pull to open, full extension drawers with 4 way adjustment (40kg weight capacity)
3. Wall hangers with 2 way adjustment and safety lock (120kg weight capacity when fitted to solid wall)
4. Easy to design and fit modular system

Finishes

All our finishes are designed to be visually striking whilst offering high levels of durability. They are manufactured from 80% renewable sources.



Matt White

Lacquered finish
ACTIVE antibacterial
Anti fingerprint



Windsor Oak

Authentic wood effect
Matching edging
PU
Antibacterial*



Matt Black

Lacquered finish
ACTIVE antibacterial
Anti fingerprint



Storm Grey Matt

Lacquered finish
ACTIVE antibacterial
Anti fingerprint



White Gloss

Lacquered finish
ACTIVE antibacterial

Worktops



Carrara Marble Effect

Supplied undrilled
Easy clean, highly heat resistant solid surface
Impenetrable to dust, dirt and bacteria



Polar White Matt

Supplied undrilled
Easy clean, highly heat resistant solid surface
Impenetrable to dust, dirt and bacteria



Windsor Oak

Supplied undrilled
18mm high density core board
Resistant to day to day wear and tear

Handles



Chrome



Matt Black



Brushed Brass



Brushed Stainless Steel Effect

Optional Porcelain Tile Drawer Front

4mm thick porcelain tile supplied pre-drilled for handles above. Simple on site installation. For use with infinity drawer units.

All tile fronts are designed to replicate natural materials authentically, this means there will be variance in tone, pattern and colour appearance - making every tile unique.



Carrara Marble Effect



Marquina Marble Effect



Cement Effect

* tested according to JIS Z 2801/ISO22196



INFINITY Made Easy

Infinity modular units can be used to design your personalised storage solution; with our drawer units, shelving units and worktops the layout options are almost infinite.

Choose your layout

Infinity drawer and shelving units can be used in combination to create layouts from 500mm to 1400mm wide. Please use the below to select your ideal layout:



500 Layout

- 1 x drawer unit
- 1 x 510mm worktop
- 1 x handle



700 Layout

- 1 x drawer unit
- 1 x shelving unit (left or right)
- 1 x 710mm worktop
- 1 x handle



900 Layout

- 1 x drawer unit
- 2 x shelving units
- 1 x 910mm worktop
- 1 x handle



1000 Layout

- 2 x drawer units
- 1 x 1010mm worktop
- 2 x handles



1200 Layout

- 2 x drawer units
- 1 x shelving unit (position left, right or centre of drawers)
- 1 x 1210mm worktop
- 2 x handles



1400 Layout

- 2 x drawer units
- 2 x shelving units
- 1 x 1410mm worktop
- 2 x handles

Customise to suit your style

Infinity is available in a range of finishes, making it the perfect choice for any style bathroom. Keep all the units in one colour for a cohesive look or mix and match for a bolder look.

1. Select your base units



White Matt



Windsor Oak



Matt Black



Storm Grey Matt



White Gloss

2. Select your worktops



Carrara Marble Effect



Polar White



Windsor Oak

3. Pick your handle



Chrome



Matt Black



Brushed Brass



Brushed Stainless Steel Effect

4. Add finishing touches



Carrara Marble Effect Tile Front



Marquina Marble Effect Tile Front



Cement Effect Tile Front



Worktop
Choice of 3 finishes

Handle
Choice of 4 finishes

Shelving Unit
Choice of 5 finishes

**Porcelain Tile
Drawer Front**
Choice of 3 finishes

Single Drawer Unit
Choice of 5 finishes



INFINITY Modular Units

500 Drawer Units



NEW

White Matt

w 500 x d 450 x h 450mm

IF5000DWM

£595



Windsor Oak

w 500 x d 450 x h 450mm

IF5000DWO

£585



Matt Black

w 500 x d 450 x h 450mm

IF5000DBM

£585



Storm Grey Matt

w 500 x d 450 x h 450mm

IF5000DSG

£585



White Gloss

w 500 x d 450 x h 450mm

IF5000DWG

£585

200 Shelving Units



NEW

White Matt

w 200 x d 450 x h 450mm

IF2052WM

£265



Windsor Oak

w 200 x d 450 x h 450mm

IF2052WO

£210



Matt Black

w 200 x d 450 x h 450mm

IF2052BM

£250



Storm Grey Matt

w 200 x d 450 x h 450mm

IF2052SG

£250



White Gloss

w 200 x d 450 x h 450mm

IF2052WG

£245

Worktops



Carrara Marble Effect

NEW

d 455 x h 12.5mm

510mm

IF5100TMC+

£370

710mm

IF7100TMC+

£455

910mm

IF9100TMC+

£570

1010mm

IF1010TMC+

£570

1210mm

IF1210TMC+

£690

1410mm

IF1410TMC+

£690



Polar White

NEW

d 455 x h 12.5mm

510mm

IF5100TPW

£260

710mm

IF7100TPW

£320

910mm

IF9100TPW

£405

1010mm

IF1010TPW

£405

1210mm

IF1210TPW

£490

1410mm

IF14100TPW

£490



Windsor Oak

d 455 x h 19mm

510mm

IF5100TWO

£150

710mm

IF7100TWO

£165

910mm

IF9100TWO

£175

1010mm

IF1010TWO

£190

1210mm

IF1210TWO

£210

1410mm

IF14100TWO

£235

Optional Extras



Anthracite Internal Drawer

When using the internal drawer an extended height basin tap can only be fitted behind the basin inline with waste cut out

IF5000INT

£245

Optional Tile Fronts

Our tile fronts are designed to replicate natural materials authentically, this means there will be variance in tone, pattern and colour appearance.



NEW

Carrara Marble Effect

For use with Infinity drawer units

IFCARRARA

£260



NEW

Marquina Marble Effect

For use with Infinity drawer units

IFMARQUINA

£260



NEW

Cement Effect

For use with Infinity drawer units

IFCEMENT

£260



Short Furniture Trap

Height adjustable. 40.6L/min flow rate
Fits 32-43mm waste pipe. 50mm water seal
Conforms to BS EN 274-1:2002

BTR0510W

£30

Handle Options must be ordered separately



Chrome

Chrome plated aluminium

IF_HANDLEC

£40



Matt Black

Epoxy coated aluminium

IF_HANDLEBM

£40



Brushed Brass

Anodised aluminium

IF_HANDLEF

£45



Brushed Stainless Steel Effect

Anodised aluminium

IF_HANDLEV

£45



All Infinity tile fronts are designed to replicate natural materials authentically, this means there will be variance in tone, pattern and colour appearance - making every tile unique.



INFINITY

Toilet Furniture Units

Uncut fascia with removable top and adjustable feet. Suitable for toilet frame WCF82X50+ and concealed cisterns WCC47X46+2 or WCC33X31+. Requires assembly before installation.



NEW
White Matt

w 545 x d 225 x h 920mm

SP5492WM £255



Windsor Oak

w 545 x d 225 x h 920mm

SP5492WO £305



Matt Black

w 545 x d 225 x h 920mm

SP5492BM £255



Storm Grey Matt

w 545 x d 225 x h 920mm

SP5492SG £255



White Gloss

w 545 x d 225 x h 920mm

SP5492WG £270

Recommended Basins see page 92 for our full list of compatible basins



NEW
Circus Brushed Brass Effect

w 400 x d 400 x h 150mm

CT4084UCF £990



Castellon Carrara Marble/White

w 430 x d 430 x h 148mm

CT0012BSCM+ £700



Fontana

w 400 x d 400 x h 115mm

CT4040UCW £335



Real Square

w 410 x d 410 x h 145mm

CT4071UCW £280



NEW
Circus

w 400 x d 400 x h 150mm

CT4084UCW £320



NEW
Castellon Mini

w 350 x d 350 x h 140mm

CT4015SCW £175



NEW
Navona

w 450 x d 350 x h 120 mm

CT08801SCW £400



NEW
Calpe

w 400 x d 400 x h 115mm

CT4090UCW £435

Optional Overflow Cover



Chrome

Chrome plated brass

OVFLOWC £15



Matt Black

Epoxy coated steel

OVFLOWMB £15



Brushed Brass

PVD brass

OVFLOWF £15



Brushed Stainless Steel Effect

PVD brass

OVFLOWV £15

Basin Wastes



Ceramic Basin Click Clack Waste

Slotted waste
Standard White

BSW0103GW+ £89



Ceramic Basin Click Clack Waste

Unslotted waste
Standard White

BSW0101GW+ £89

Universal Basin Wastes

We have a wide selection of universal basin click clack wastes that perfectly matching our best selling brassware finishes.

If you are looking to co-ordinate your basin waste with your brassware see page 104.







ZION

Sleek handleless styling in classic finishes with full depth, full extension drawers. Zion combines a deep basin and on trend styling to bring you the ultimate vanity unit for the bathroom.



10 Year Guarantee*
Peace of mind



Ceramic basin p 78
Toilet furniture units p 78



ZION

Product Highlights

1. Fully assembled floor standing
2. Handleless, soft close, pull to open, full extension drawers with 4 way adjustment (40kg weight capacity)
3. Height adjustable feet
4. Top drawer cut out for services

Finishes



Windsor Oak

Authentic wood effect
Matching edging
Antibacterial*



Storm Grey Matt

Lacquered finish
ACTIVE antibacterial
Anti fingerprint



White Gloss

Lacquered finish
ACTIVE antibacterial

Basin



Ceramic

Fine fire clay

Overflow colour options available see p 105



ZION Floor Standing with White Fine Fire Clay Basin

600

600 Double Drawer Unit
w 600 x d 368 x h 795mm (w/ basin 870mm)

600 1TH Basin with Overflow
w 610 x d 370/400 x h 75mm

Windsor Oak



Unit **ZI6000DWO+** £750
Basin **ZI0611SCW** £420

£1170

700

700 Double Drawer Unit
w 700 x d 368 x h 795mm (w/ basin 870mm)

700 1TH Basin with Overflow
w 710 x d 370/400 x h 75mm



Unit **ZI7000DWO+** £820
Basin **ZI0711SCW** £465

£1285

1200 LH

1200 Double Drawer Unit LH
w 1200 x d 368 x h 795mm (w/ basin 870mm)

1200 1TH Basin with Overflow LH
w 1210 x d 370/400 x h 75mm



Unit **ZI1200DWO+** £1140
Basin **ZI1211SCW_LH** £915

£2055

1200 RH

1200 Double Drawer Unit RH
w 1200 x d 368 x h 795mm (w/ basin 870mm)

1200 1TH Basin with Overflow RH
w 1210 x d 370/400 x h 75mm



Unit **ZI1200DWO+** £1140
Basin **ZI1211SCW_RH** £915

£2055

Storm Grey Matt



Unit **ZI6000DSG+** £735
Basin **ZI0611SCW** £420

£1155



Unit **ZI7000DSG+** £820
Basin **ZI0711SCW** £465

£1285



Unit **ZI1200DSG+** £1030
Basin **ZI1211SCW_LH** £915

£1945



Unit **ZI1200DSG+** £1030
Basin **ZI1211SCW_RH** £915

£1945

White Gloss



Unit **ZI6000DWG+** £655
Basin **ZI0611SCW** £420

£1075



Unit **ZI7000DWG+** £720
Basin **ZI0711SCW** £465

£1185



Unit **ZI1200DWG+** £990
Basin **ZI1211SCW_LH** £915

£1905



Unit **ZI1200DWG+** £990
Basin **ZI1211SCW_RH** £915

£1905

Toilet Furniture Units

Uncut fascia with removable top and adjustable feet. Suitable for toilet frame WCF82X50+ and concealed cisterns WCC47X46+2 or WCC33X31+. Requires assembly before installation.



Windsor Oak

w 545 x d 225 x h 920mm

SP5492WO **£305**



Storm Grey Matt

w 545 x d 225 x h 920mm

SP5492SG **£255**



White Gloss

w 545 x d 225 x h 920mm

SP5492WG **£270**



We recommend this for full use of drawers

Short Furniture Trap

Height adjustable. 40.6L/min flow rate
Fits 32-43mm waste pipe. 50mm water seal
Conforms to BS EN 274-1:2002

BTR0510W **£30**

Optional Overflow Cover



Chrome

Chrome plated brass

OVFLOWC **£15**



Matt Black

Epoxy coated steel

OVFLOWMB **£15**



Brushed Brass

PVD brass

OVFLOWF **£15**



Brushed Stainless Steel Effect

PVD brass

OVFLOWV **£15**







KAI

A truly spacious and affordable storage solution for the bathroom. Whether you choose the single drawer option, or upgrade to the sleek two drawer, all vanities are wonderfully completed.



10 Year Guarantee*
Peace of mind



White worktop p 84
Ceramic basin p 86
Toilet furniture units p 88



Product Highlights

1. Fully assembled with integrated aluminium handle
2. Soft close, pull to open, full extension drawers (25kg weight capacity)
3. Wall hangers with 2 way adjustment (90kg weight capacity when fitted to solid wall)
4. Single or double drawer unit available

Finishes

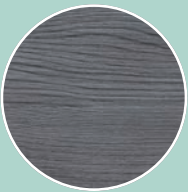

Grey Oak

Authentic wood effect



Grey Gloss

Lacquered finish



White Gloss

Lacquered finish

Worktop



White Gloss

Supplied undrilled

19mm thick HPL faced chipboard

Post formed front edge

Complies with BS EN EN 438-2

Basin



Ceramic

Fine Fire Clay

Supplied with chrome overflow cover



























KAI Drawer Unit with White Gloss Worktop

500		600		800		1000		
500 Single or Double Drawer Unit w 503 x d 454 x h 480mm (w/ top 520mm)		600 Single or Double Drawer Unit w 603 x d 454 x h 480mm (w/ top 520mm)		800 Single or Double Drawer Unit w 803 x d 454 x h 480mm (w/ top 520mm)		1000 Single or Double Drawer Unit w 1003 x d 454 x h 480mm (w/ top 520mm)		
500 Worktop w 505 x d 454 x h 40mm		600 Worktop w 605 x d 454 x h 40mm		800 Worktop w 805 x d 454 x h 40mm		1000 Worktop w 1005 x d 454 x h 40mm		
Grey Oak								
1 Drawer Unit	KL5000DGO	£390	1 Drawer Unit	KL6000DGO	£400	1 Drawer Unit	KL1000DGO	£525
Worktop	KL5000TWG	£105	Worktop	KL6000TWG	£120	Worktop	KL1000TWG	£180
£495		£520		£590		£705		
2 Drawer Unit								
1 Drawer Unit	KL5200DGO	£470	1 Drawer Unit	KL6200DGO	£490	1 Drawer Unit	KLX1000DGO	£620
Worktop	KL5000TWG	£105	Worktop	KL6000TWG	£120	Worktop	KL1000TWG	£180
£575		£610		£685		£800		
Grey Gloss								
1 Drawer Unit	KL5000DGG	£405	1 Drawer Unit	KL6000DGG	£425	1 Drawer Unit	KL1000DGG	£555
Worktop	KL5000TWG	£105	Worktop	KL6000TWG	£120	Worktop	KL1000TWG	£180
£510		£545		£615		£735		
2 Drawer Unit								
1 Drawer Unit	KL5200DGG	£495	1 Drawer Unit	KL6200DGG	£510	1 Drawer Unit	KLX1000DGG	£650
Worktop	KL5000TWG	£105	Worktop	KL6000TWG	£120	Worktop	KL1000TWG	£180
£600		£630		£720		£830		
White Gloss								
1 Drawer Unit	KL5000DWG	£390	1 Drawer Unit	KL6000DWG	£400	1 Drawer Unit	KL1000DWG	£525
Worktop	KL5000TWG	£105	Worktop	KL6000TWG	£120	Worktop	KL1000TWG	£180
£495		£520		£590		£705		
2 Drawer Unit								
1 Drawer Unit	KL5200DWG	£470	1 Drawer Unit	KL6200DWG	£490	1 Drawer Unit	KLX1000DWG	£620
Worktop	KL5000TWG	£105	Worktop	KL6000TWG	£120	Worktop	KL1000TWG	£180
£575		£610		£685		£800		



KAI Drawer Unit with Ceramic Basin

500		600		800		1000	
500 Single or Double Drawer Unit w 503 x d 454 x h 480mm		600 Single or Double Drawer Unit w 603 x d 454 x h 480mm		800 Single or Double Drawer Unit w 803 x d 454 x h 480mm		1000 Single or Double Drawer Unit w 1003 x d 454 x h 480mm	
500 1TH Basin with Overflow w 510 x d 460 x h 20mm		600 1TH Basin with Overflow w 610 x d 460 x h 20mm		800 1TH Basin with Overflow w 810 x d 460 x h 20mm		1000 1TH Basin with Overflow w 1010 x d 460 x h 20mm	
Grey Oak							
	1 Drawer Unit Basin	KL5000DGO DE0002SCW+	£390 £190		1 Drawer Unit Basin	KL6000DGO KL0611SCW	£400 £185
		£580				£585	
	1 Drawer Unit Basin	KL8000DGO KL0811SCW	£435 £200		1 Drawer Unit Basin	KL1000DGO KL1000SCW	£525 £290
		£635				£815	
	2 Drawer Unit Basin	KL5200DGO DE0002SCW+	£470 £190		2 Drawer Unit Basin	KL6200DGO KL0611SCW	£490 £185
		£660				£675	
	2 Drawer Unit Basin	KL8200DGO KL0811SCW	£530 £200		2 Drawer Unit Basin	KLX1000DGO KL1000SCW	£620 £290
		£730				£910	
Grey Gloss							
	1 Drawer Unit Basin	KL5000DGG DE0002SCW+	£405 £190		1 Drawer Unit Basin	KL6000DGG KL0611SCW	£425 £185
		£595				£610	
	1 Drawer Unit Basin	KL8000DGG KL0811SCW	£460 £200		1 Drawer Unit Basin	KL1000DGG KL1000SCW	£555 £290
		£660				£845	
	2 Drawer Unit Basin	KL5200DGG DE0002SCW+	£495 £190		2 Drawer Unit Basin	KL6200DGG KL0611SCW	£510 £185
		£685				£695	
	2 Drawer Unit Basin	KL8200DGG KL0811SCW	£565 £200		2 Drawer Unit Basin	KLX1000DGG KL1000SCW	£650 £290
		£765				£940	
White Gloss							
	1 Drawer Unit Basin	KL5000DWG DE0002SCW+	£390 £190		1 Drawer Unit Basin	KL6000DWG KL0611SCW	£400 £185
		£580				£585	
	1 Drawer Unit Basin	KL8000DWG KL0811SCW	£435 £200		1 Drawer Unit Basin	KL1000DWG KL1000SCW	£525 £290
		£635				£815	
	2 Drawer Unit Basin	KL5200DWG DE0002SCW+	£470 £190		2 Drawer Unit Basin	KL6200DWG KL0611SCW	£490 £185
		£660				£675	
	2 Drawer Unit Basin	KL8200DWG KL0811SCW	£530 £200		2 Drawer Unit Basin	KLX1000DWG KL1000SCW	£620 £290
		£730				£910	

Basins conform to BS EN 14688:2015 + a1:2018. Due to ceramic manufacturing processes all dimensions printed are approximate.



Toilet Furniture Units

Uncut fascia with removable top and adjustable feet. Suitable for toilet frame WCF82X50+ and concealed cisterns WCC47X46+2 or WCC33X31+. Requires assembly before installation.



Grey Oak

w 545 x d 225 x h 920mm

KL15492GO

£195



Grey Gloss

w 545 x d 225 x h 920mm

KL15492GG

£220



White Gloss

w 545 x d 225 x h 920mm

KL15492WG

£195

Recommend Basins for use with Worktops see page 92 for our full list of compatible basins



Navona

w 450 x d 350 x h 120mm

CT08801SCW

£400



Real Square

w 410 x d 410 x h 145mm

CT4071UCW

£280



Fontana

w 400 x d 400 x h 115mm

CT4040UCW

£335



Gerona

w 425 x d 305 x h 130mm

CT0037UCW

£290

Basin Waste

Recommended for use with Kai worktops



Chrome

For basins with or without an overflow

BSW0260C

£59



Brushed Brass

For basins with or without an overflow

BSW0290F

£139



Brushed Stainless Steel Effect

For basins with or without an overflow

PRO0260V+

£139



Matt Black

For basins with or without an overflow

PRO0260M+

£139

Optional Overflow Cover



Matt Black

Epoxy coated steel

OVFLOWMB

£15



Brushed Brass

PVD brass

OVFLOWF

£15



Brushed Stainless Steel Effect

PVD brass

OVFLOWV

£15

Trap Fittings



Short Furniture Trap

Height adjustable. 40.GL/min flow rate
Fits 32-43mm waste pipe. 50mm water seal
Conforms to BS EN 274-1:2002

BTR0510W

£30



Furniture Basin Trap

Extra slim push-fit trap. Fits 1 1/4" waste pipe.
Horizontal or vertical
Min height under basin: 54mm

BTR0410W

£45



Choosing your Basin

Crosswater basins are available in wide range of styles, installation types, materials and finishes. Allowing you to choose your perfect basin no matter your space, furniture unit or style. Crosswater basins use materials such as fine fire clay allowing for more complex designs and super-slim edge profiles, cast marble which offers a wide range of colour finishes and strong scratch proof PLUS+TON®.

Countertop

Countertops basins are the ideal choice if you want to create a luxury style. Available in a range of shapes, this type of basin has been designed to be fitted on top of a worktop or solid surface, Crosswater's offer includes ranges with a tap hole and some without. No tap hole variants are usually teamed with a tall monobloc or wall mounted mixer tap.

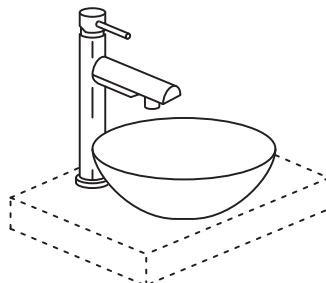

Tall Monobloc Tap

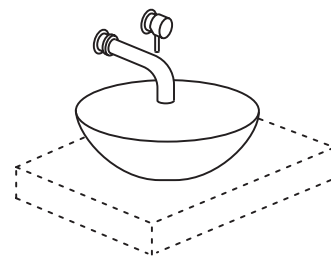

Wall Mounted Tap

Back to Wall Countertop & Wall Mounted

Many of our wall hung basins are perfect for use as a countertop basin on furniture when fitted directly against a wall in addition to being used as a normal wall hung basin. These basins have the flexibility of having a tap hole to match up with a standard monobloc mixer tap. A wide ranging selection of sizes, styles, and bowl depths to choose from whatever your bathroom requirement.

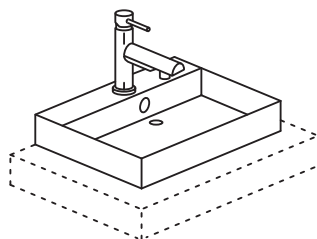

Countertop

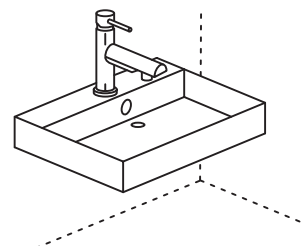

Wall Hung

Undermount & Inset

Undermount and inset basins are a favourite in many high end hotels, offering a simple yet stylish appearance with plenty of worktop space for taps, toiletries and soaps. Worktops need to be pre-cut to accept the basins and are secured to the underside of the worktop using metal brackets and silicone.

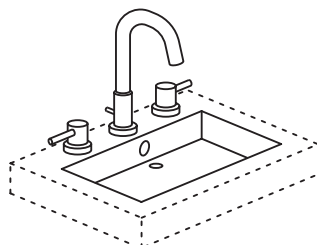

Deck Mounted 3 Tap Hole with Undermount Basin

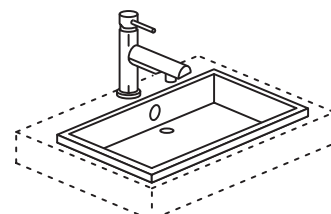

Monobloc Mixer with Inset Basin

Basin Waste Options

Depending on your design preference your basin may have an in built water overflow or not. It's important to choose the right waste to suit your basin.

If your basin has an overflow, it will require a slotted basin waste to allow the water to flow into the waste. If you have no overflow on your basin, you need an unslotted waste. Crosswater also offer a universal waste which is compatible with most slotted and unslotted basins.

Please use the matrix on the opposite page to ensure you select the correct waste.



Slotted



Unslotted



Universal

Complementary Brassware

Selecting the right tap for your basin is essential to achieve your desired look and performance. Always select the basin before the mixer fittings and ensure you choose a washbasin that can accommodate the style and size of your choice of mixer. When choosing a basin and mixer, consider your water pressure. Higher water pressures or pumped water supply systems will influence the suitability of your chosen tap and basin, so take note of your water pressure. A high pressure reducing valve or flow restrictor will give you added flexibility.

Our Portfolio

	Countertop page 94	Back to Wall Countertop page 97	Cloakroom page 98	Wall Mounted page 100	Undermount page 102	Inset page 102	With Overflow	Without Overflow	Unslotted Waste Required	Slotted Waste Required	Deck Mounted Basin Mixer	Tall Basin Monobloc	Wall Mounted Basin Mixer
Air 60		●		●			●			●	●		
Alice	●							●	●			●	●
Amalfi	●							●	●			●	●
Ancona					●		●			●	●		●
Calpe	●							●	●				
Castellon	●						●			●		●	●
Castellon Mini	●						●			●		●	●
Cerdeña					●		●			●	●		●
Circus	●						●					●	●
Circus Mini	●						●				●		●
Fontana	●							●	●			●	●
Gerona		●		●				●	●		●		
Kai S Corner				●			●			●	●		
Navarre	●						●			●		●	●
Navona		●		●			●			●	●		
Nepi						●		●	●		●		●
Pearl No O/F	●							●	●			●	●
Pearl with O/F	●						●			●		●	●
Popolo			●	●			●			●	●		
Real Counter	●							●	●			●	●
Real Square	●							●	●			●	●
Serene	●							●	●			●	●
Torino A Midi					●		●			●		●	●
Torino B Small					●		●			●		●	●
Trinta	●							●	●			●	●
Turin		●		●			●			●	●		



Basin & Furniture Compatibility

To ensure your bathroom functions and looks as good as you dream it will, we have carefully selected ranges that complement each other beautifully. Please use the table below to find out which basins are compatible with your chosen furniture unit with worktop:

	ARTIST® with worktop			GLIDE II with work top			ARENA with worktop			SVELTE with worktop			INFINITY with worktop	KAI with worktop				
	600	800	1000	500	700	1000	600	700	1000	600	800	1000	500	500	600	800	1000	
Air 60				●	●	●											●	●
Alice	●	●	●		●	●	●	●	●		●	●				●	●	●
Amalfi	●	●	●							●	●	●		●	●	●	●	
Calpe	●	●	●	●	●	●				●	●	●	●		●	●	●	
Castellon	●	●	●	●	●	●				●	●	●	●	●	●	●	●	
Castellon Mini	●	●	●	●	●	●	●	●	●	●	●	●	●	●	●	●	●	
Circus	●	●	●	●	●	●	●	●	●	●	●	●	●	●	●	●	●	
Circus Mini	●	●	●				●	●	●	●	●	●	●	●	●	●	●	
Fontana	●	●	●	●	●	●				●	●	●	●	●	●	●	●	
Gerona	●	●	●	●	●	●	●	●	●				●	●	●	●	●	
Navarre		●	●		●	●		●	●			●				●	●	
Navona	●	●	●	●	●	●	●	●	●				●	●	●	●	●	
Nepi	●	●	●							●		●						
Pearl	●	●	●	●	●	●	●	●	●	●	●	●	●	●	●	●	●	
Real Counter	●	●	●		●	●				●	●	●			●	●	●	
Real Square	●	●	●	●	●	●				●	●	●	●	●	●	●	●	
Serene		●	●		●	●	●	●	●		●	●				●	●	
Turin	●	●	●		●	●	●	●	●						●	●	●	

Thicker Worktops

We recommend an extended waste when fitting a basin to Artist™, Glide II, Svelte, Infinity and Kai worktops



COUNTERTOP



Lifetime Guarantee*
Peace of mind





Add a bit of luxury to your bathroom

Our new Circus basins have our thinnest edge yet! The Brushed Brass Effect and Brushed Stainless Steel Effect exterior are hand finished, with smooth easy clean Matt Cru interior.



NEW
Circus Brushed Brass Effect

Interior: Matt Cru. Exterior: Brushed Brass effect
No overflow. Slimline edge. Vitreous china
Countertop only
w 400 x d 400 x h 150mm

CT4084UCF

£990



NEW
Circus Brushed Stainless Steel Effect

Interior: Matt Cru. Exterior: Brushed Stainless Steel effect
No overflow. Slimline edge. Vitreous china
Countertop only
w 400 x d 400 x h 150mm

CT4084UCV

£990



NEW
Circus

No overflow. Slimline edge
White vitreous china
Countertop only
w 400 x d 400 x h 150mm

CT4084UCW

£320



NEW
Circus Mini

No overflow. Slimline edge
White vitreous china
Countertop only
w 230 x d 230 x h 130mm

CT4912UCW

£195



NEW
Castellon Mini

With overflow, option to add a coloured overflow, see p 105
Countertop only
White fine fireclay ceramic
w 350 x d 350 x h 140mm

CT4015SCW

£175



Castellon Carrara Marble/White PLUS

Interior: Gloss white internal. Exterior: Carrara Marble Décor
With overflow, option to add a coloured overflow, see p 105
Fine fireclay ceramic
Countertop only
w 430 x d 430 x h 148mm

CT0012BSCM+

£700



Castellon PLUS

With overflow, option to add a coloured overflow, see p 105
White fine fireclay ceramic
Countertop only
w 430 x d 430 x h 148mm

CT0012BSCW+

£305





Pearl Matt White PLUS+TON®

With overflow and antibacterial finish. Slimline edge
 Option to add a coloured overflow, see p 105
 White fine fireclay ceramic. Countertop only
 w 450 x d 350 x h 158mm

CT05823SCWM

£670



Pearl Storm PLUS+TON®

With overflow and antibacterial finish. Slimline edge
 Option to add a coloured overflow, see p 105
 Storm grey fine fireclay ceramic. Countertop only
 w 450 x d 350 x h 158mm

CT05823SCSG

£670



Pearl

No overflow
 White fine fireclay ceramic
 Countertop only
 w 450 x d 350 x h 150mm

CT05823UCW

£370



Pearl

With overflow, option to add a coloured overflow, see p 105
 White fine fireclay ceramic
 Countertop only
 w 450 x d 350 x h 158mm

CT05823SCW

£360



Amalfi

No overflow. Slimline edge
 White vitreous china
 Countertop only
 w 400 x d 400 x h 135mm

CT4432UCW

£320



Serene

No overflow. Slimline edge
 White fine fireclay ceramic
 Countertop only
 w 580 x d 350 x h 150mm

CT0234UCW

£485



Navarre

With overflow, option to add a coloured overflow, see p 105
 White vitreous china
 Countertop only
 w 590 x d 420 x h 140mm

CT4038SCW

£355



Trinta

No overflow. Slimline edge
 White vitreous china
 Countertop only
 w 500 x d 405 x h 105mm

CT50405UCW

£335



NEW
Calpe

No overflow. Slimline edge
 White vitreous china
 Countertop only
 w 400 x d 400 x h 115mm

CT4090UCW

£435



Real Counter

No overflow. Slimline edge
White vitreous china
Countertop only
w 490 x d 400 x h 145mm

CT4072UCW

£320



Real Square

No overflow. Slimline edge
White vitreous china
Countertop only
w 410 x d 410 x h 145mm

CT4071UCW

£280



Alice

No overflow
High gloss white cast mineral marble
Countertop only
w 560 x d 327 x h 187mm

CT5637URW

£590



NEW

Navona

With overflow and 1TH
White fine fireclay ceramic
Countertop, back to wall or wall mount
w 450 x d 350 x h 120mm

CT08801SCW

£400



Fontana

No overflow and 1TH
White fine fireclay ceramic
Countertop only
w 400 x d 400 x h 110mm

CT4040UCW

£335



Air 60

With overflow and 1TH
Option to add a coloured overflow, see p 105
White fine fireclay ceramic. Countertop or back to wall
w 600 x d 390 x h 135mm

WM0132SCW

£390



Turin

With overflow and 1TH
Optional coloured overflow, see p 105
White fine fireclay ceramic. Countertop or back to wall
w 500 x d 350 x h 120mm

WM0017BSCW

£305



Gerona

No overflow and 1TH
White vitreous china
Countertop or back to wall
w 425 x d 305 x h 130mm

CT0037UCW

£290



CLOAKROOM



Made In Italy
Designed for UK



Lifetime Guarantee*
Peace of mind





NEW

Popolo Matt White

Left hand. With overflow and 1TH
 Option to add a coloured overflow, see p 105
 Fine fireclay ceramic
 Wall mount only - supplied with wall fixings
 w 480 x d 250 x h 160mm

WM4825SCWM_LH

£520



NEW

Popolo Matt Black

Left hand. With overflow and 1TH
 Option to add a coloured overflow, see p 105
 Fine fireclay ceramic
 Wall mount only - supplied with wall fixings
 w 480 x d 250 x h 160mm

WM4825SCBM_LH

£520



NEW

Popolo

Left hand. With overflow and 1TH
 Option to add a coloured overflow, see p 105
 Fine fireclay ceramic
 Wall mount only - supplied with wall fixings
 w 480 x d 250 x h 160mm

WM4825SCW_LH

£375



NEW

Popolo Matt White

Right hand. With overflow and 1TH
 Option to add a coloured overflow, see p 105
 Fine fireclay ceramic
 Wall mount only - supplied with wall fixings
 w 480 x d 250 x h 160mm

WM4825SCWM_RH

£520



NEW

Popolo Matt Black

Right hand. With overflow and 1TH
 Option to add a coloured overflow, see p 105
 Fine fireclay ceramic
 Wall mount only - supplied with wall fixings
 w 480 x d 250 x h 160mm

WM4825SCBM_RH

£520



NEW

Popolo

Right hand. With overflow and 1TH
 Option to add a coloured overflow, see p 105
 Fine fireclay ceramic
 Wall mount only - supplied with wall fixings
 w 480 x d 250 x h 160mm

WM4825SCW_RH

£375



WALL MOUNTED



Lifetime Guarantee*
Peace of mind





Air 60

With overflow, option to add a coloured overflow, see p 105
 White fine fireclay ceramic
 Countertop or back to wall
 w 600 x d 390 x h 135mm

WM0132SCW

£390



Turin

With overflow, option to add a coloured overflow, see p 105
 White vitreous china
 Countertop or back to wall
 w 500 x d 350 x h 120mm

WM0017BSCW

£305



Gerona

No overflow
 White vitreous china
 Countertop or back to wall
 w 425 x d 305 x h 130mm

CT0037UCW

£290



NEW

Navona

With overflow and 1TH
 White fine fireclay ceramic
 Countertop, back to wall or wall mount
 w 450 x d 350 x h 120mm

CT08801SCW

£400



Kai S Corner Basin

With overflow and antibacterial finish
 Option to add a coloured overflow, see p 105
 White fine fireclay ceramic
 Wall mount only - supplied with concealed fixing kit
 w 450 x d 350 x h 158mm

KLSC01SCW

£165



UNDERMOUNT AND INSET



Lifetime Guarantee*
Peace of mind





Torino A Midi

With overflow, option to add a coloured overflow, see p 105
White vitreous china. Undermount only
w 510 x d 380 x h 195mm (internal w 455 x d 310mm)

UM0051SCW **£285**

Required undermount fixings

T/0051 **£25**



Torino B Small

With overflow, option to add a coloured overflow, see p 105
White vitreous china. Undermount only
w 510 x d 325 x h 170mm (internal w 450 x d 270mm)

UM0051BSCW **£255**

Required undermount fixings

T/0051 **£25**



Ancona

With overflow, option to add a coloured overflow, see p 105
White fine fireclay ceramic. Undermount only
w 570 x d 400 x h 215mm (internal w 520 x d 360mm)

UM5740UCW **£240**

Required undermount fixings

T/0051 **£25**



Cerdeña

With overflow, option to add a coloured overflow, see p 105
White vitreous china. Undermount only
Supplied complete with template and undermount fixings
w 380 x d 380 x h 170mm (internal w 326 x d 326mm)

UM0052SCW+ **£185**



NEW
Nepi

No overflow
White fine fireclay ceramic
Inset/drop in only
w 400 x d 400 x h 205mm (internal h 195mm)
Supplied complete with template (cut out diameter 380mm)

IN84100UCW **£455**



Important Installation Information

It is recommended to template worktop cut outs to the actual basin.



WASTES, OVERFLOW COVERS & TRAPS



Lifetime Guarantee*
Peace of mind

Universal Wastes

For basins with or without an overflow.



Chrome

For basins with or without an overflow
Matches chrome brassware

BSW0260C £59



Brushed Brass

For basins with or without an overflow
Matches MPRO, Glide II and Verge brassware

BSW0290F £139



Brushed Stainless Steel Effect

For basins with or without an overflow
Matches MPRO, Glide II and Verge brassware

PRO0260V+ £139



Matt Black

For basins with or without an overflow
Matches MPRO, Glide II and Verge brassware

PRO0260M+ £139



Matt White

For basins with or without an overflow
Matches MPRO brassware

PRO0280W+ £145



Carbon Black

For basins with or without an overflow
Matches MPRO Industrial brassware

PRI0260M £139



Unlacquered Brushed Brass

For basins with or without an overflow
Matches MPRO Industrial brassware

PRI0260UB £139



Unlacquered Brass

For basins with or without an overflow
Matches Belgravia brassware

BSW0260Q £139



Nickel

For basins with or without an overflow
Matches Belgravia brassware

BSW0260N £89



Chrome Free Flow Waste

For basins with or without an overflow
Matches chrome brassware

BSW0270C £55

Unslotted Wastes

For basins without an overflow.



Chrome Basin Click Clack Waste

Extended thread 100mm
For basins without an overflow

BSW0102C £75



Ceramic Basin Click Clack Waste

For ceramic basins without an overflow
White plug with chrome body

BSW0101GW+ £89



Chrome Basin Click Clack Waste

For basins with an overflow

BSW0103C £69

Extended Thread 100mm

BSW0104C £75



Ceramic Basin Click Clack Waste

For ceramic basins with an overflow
White plug with chrome body

BSW0103GW+ £89

Slotted Wastes

For basins with an overflow.

Overflow Covers



Chrome

Chrome plated brass

OVFLOWC

£15



Matt Black

Epoxy coated steel

OVFLOWMB

£15



Brushed Brass

PVD brass

OVFLOWF

£15



Brushed Stainless Steel Effect

PVD brass

OVFLOWV

£15

Overflow Covers Basin Compatibility

Overflow covers can be used with the following Furniture basins: Arena, Zion, Svelte cast mineral marble, Glide II cast mineral marble and ceramic.

Overflow covers can be used with the following basins:

- CT0012BSCM+
- CT0012BSCW+
- CT4015SCW
- CT05823SCW
- CT05823SCWM
- CT4038SCW
- WM0132SCW
- WM0017BSCW
- WM4825SCBM_LH
- WM4825SCBM_RH
- WM4825SCWM_LH
- WM4825SCWM_RH
- WM4825SCCW_LH
- WM4825SCCW_RH
- UM0051SCW
- UM0051BSCW
- UM5740UCW
- UM0052SCW

Basin & Furniture Traps



Chrome

Millennium Tall Bottle Trap
With 400mm pipe
Matches chrome brassware

BTR0402C

£69



Brushed Brass

Millennium Tall Bottle Trap
With 400mm pipe
Matches MPRO, Glide II and Verge brassware

PRO0402F+

£219



Brushed Stainless Steel Effect

Millennium Tall Bottle Trap
With 400mm pipe
Matches MPRO, Glide II and Verge brassware

PRO0402V+

£219



Matt Black

Millennium Tall Bottle Trap
With 400mm pipe
Matches MPRO, Glide II and Verge brassware

PRO0402M+

£219



Matt White

Millennium Tall Bottle Trap
With 400mm pipe
Matches MPRO, Glide II and Verge brassware

PRO0402W+

£219



Short Furniture Trap

Height adjustable. 40.6L/min flow rate
Fits 32-43mm waste pipe. 50mm seal
Conforms to BS EN 274-1:2002

BTR0510W

£30



Furniture Basin Trap

Extra slim push-fit trap. Fits 1 1/4" waste pipe.
Horizontal or vertical
Min height under basin: 54mm

BTR0410W

£45



Choosing your Toilet

Crosswater toilets are available in many design styles so you can easily create a look that's perfect for your bathroom. Each toilet is made from 100% non-porous vitreous china and is designed to conceal all pipe work for a clean and simple design. Crosswater toilets meet all required performance and quality standards. All Crosswater toilets have matching soft close seats and covers which are sold separately.

Compact Close Coupled

Close coupled toilets, once the most common due to ease of installation consist of 2 parts, where the cistern including flushing mechanism is fitted directly on top of the toilet pan. Choose from closed back to wall design to conceal pipe work from view, ensuring a neater finish and easier cleaning or open back for easier installation. All feature efficient dual flush mechanism.

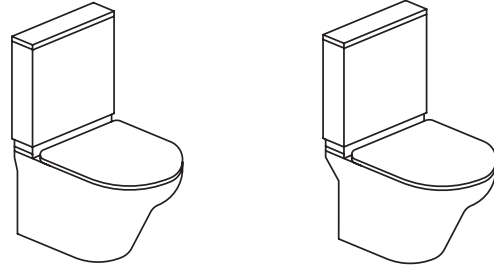

Back to Wall

Floor standing back to wall toilets do not need any type of support frame as they are fitted to the floor and allow the toilet to have a smaller footprint in order to maximise room space. They do require the a cistern to be built into the wall or installed inside toilet furniture. Back to Wall toilets offer the best solution for a straight replacement of a close coupled toilet.

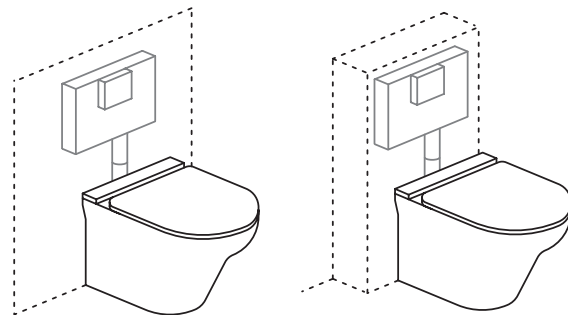

Concealed Cistern
(In Wall)

Concealed Cistern
(Toilet Furniture)

Wall Hung

Wall hung toilets feature all the space-saving benefits of a back to wall toilet and are designed to be fitted with a supporting installation frame which contains an in-built cistern. These frames can support a weight of up to 400kg for complete peace of mind and allow the user to adjust the height of the toilet to suit all the family.

Raising the toilet off the floor creates the illusion of even more space and promotes better hygiene by making cleaning the bathroom easier.

The in-wall frame can be installed in a wall cavity, or on selected models using one of our toilet furniture units on the wall removing the need for costly installation.

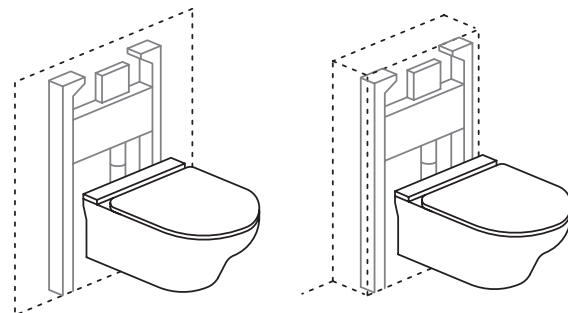

Support Frame
(In Wall)

Support Frame
(Toilet Furniture)

Rimless Design

The Crosswater toilet range presents many different and often unique styles. Some feature a tried and tested closed/box rim providing great bowl flushing.

The latest ranges are offered with a smart 'rimless' bowl format. Rimless design means 100% of the flush water is used to clean the bowl also creating not only a better looking toilet but more importantly, one which is easier to clean, resulting in much better hygiene as there is nowhere for bacteria or lime scale to accumulate.



Soft Close Seats

All Crosswater toilets feature ergonomically designed, stylish whisper-quiet soft close seats and covers, colour matched to the ceramic. Produced from high quality materials, Crosswater seats remain whiter for longer and are easy to clean.

Our Portfolio

	Close Coupled	Back to Wall	Wall Hung	Rimless	ECO Flush 3/4.5L	Quick Release Seat	Short Projection	White	Matt White
 <p>Glide II page 108</p>		●	●	●	●	●	●	●	●
 <p>Kai X page 112</p>	●	●	●		●	●	●	●	
 <p>Svelte page 116</p>		●	●	●	●			●	
 <p>Kai S page 120</p>	●	●	●		●	●	●	●	
 <p>Kai page 124</p>	●	●	●		●	●		●	







GLIDE II

Glide II toilets are designed with quality, precision and refined proportions to create beautiful shapes. As well as our classic Gloss White, selected toilets are offered in a smooth and durable Matt White ceramic which provides a more luxurious and warmer feel.

The smart rimless design creates not only a better looking toilet but a cleaner and more hygienic toilet as there is nowhere for bacteria, limescale or grime to accumulate. Additionally, the fully glazed internal waterways feature means Glide II toilets deliver complete cleanliness.



Lifetime Guarantee*
Peace of mind



Made in Italy
Designed for the UK



Rimless Design Easy
to clean



Wall Hung p 110
Back to Wall p 110



Short Projection Wall Hung Toilets



Matt White Wall Hung Short Projection Toilet

Rimless, reduced projection toilet
Soft close and quick release seat
Will flush at Eco saving 3/4.5L
Complete with concealed fixings
Requires support frame and cistern
w 370 x d 460 x h 325mm

Toilet	GL6115CWM	£705
Seat	GL6106WM	£230
		£935



Gloss White Wall Hung Short Projection Toilet

Rimless, reduced projection toilet
Soft close and quick release seat
Will flush at Eco saving 3/4.5L
Complete with concealed fixings
Requires support frame and cistern
w 370 x d 460 x h 325mm

Toilet	GL6115CW	£485
Seat	GL6106W	£160
		£645

Wall Hung Toilets



Gloss White Wall Hung Toilet

Rimless toilet
Soft close and quick release seat
Will flush at Eco saving 3/4.5L
Complete with concealed fixings
Requires support frame and cistern
w 365 x d 510 x h 345mm

Toilet	GL6116CW	£555
Seat	GL6105W	£160
		£715

Back to Wall Toilets



Matt White Back to Wall Toilet

Rimless toilet
Soft close and quick release seat
Will flush at Eco saving 3/4.5L
Complete with floor fixings
Requires concealed cistern
w 365 x d 510 x h 425mm

Toilet	GL6117CWM	£750
Seat	GL6105WM	£230
		£980



Gloss White Back to Wall Toilet

Rimless toilet
Soft close and quick release seat
Will flush at Eco saving 3/4.5L
Complete with floor fixings
Requires concealed cistern
w 365 x d 510 x h 425mm

Toilet	GL6117CW	£565
Seat	GL6105W	£160
		£725

Matt White Finish
Matches our Pearl Matt White countertop basin perfectly,
see page 96



Gloss White Finish



Space Saving

Glide II wall hung toilets are available in a 'mini' variant which is a little wider but has 2" shorter projection for rooms where optimising space is critical.

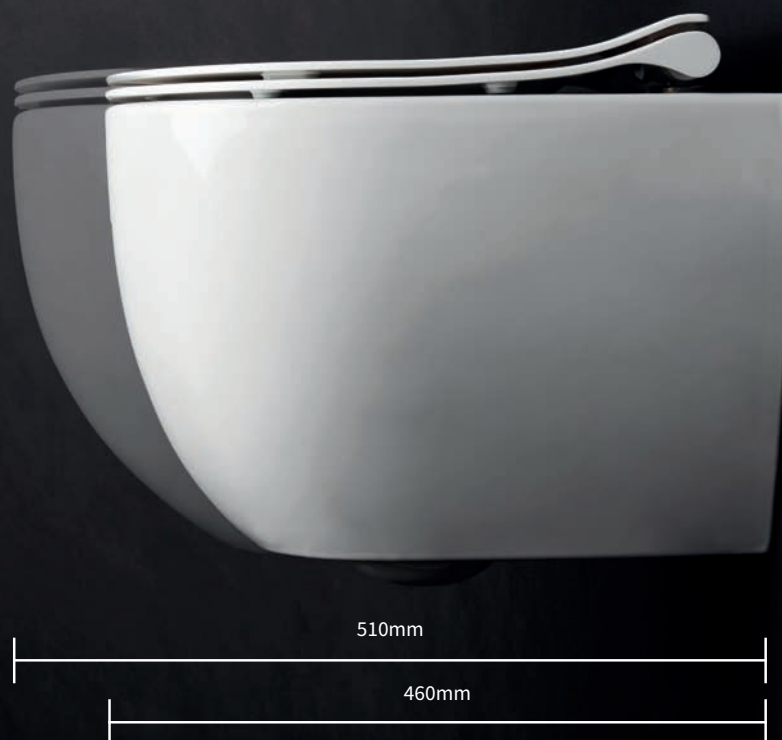

Rimless Design

Glide II rimless toilets completely revolutionises the concept of toilet flushing systems to guarantee maximum hygiene and cleanliness with powerful near silent flushing.







KAI X

A combination of aesthetics and function, our Kai X toilets are both simple and versatile in style, offering a level of design and comfort that combines effortlessly with every bathroom style.

Our Kai X range has space-saving solutions to help you make the best of your bathroom with great “compact” close coupled toilets, full back to wall or easy to install open backed - all including the very best hygienic glaze throughout.



Lifetime Guarantee*
Peace of mind



Made in Portugal
Designed for the UK

Wall Hung p 114
Back to Wall p 114
Close Coupled p 114



Wall Hung Toilets



Gloss White Wall Hung Toilet

Soft close, thin and quick release seat
Will flush at Eco saving 3/4.5L
Complete with pre-fitted concealed fixings
Factory fitted wall hung fittings
Requires support frame and cistern
w 360 x d 555 x h 400mm

Toilet	KL6206CW	£300
Seat	KL6205W	£150
		£450

Back to Wall Toilets



Gloss White Back to Wall Toilet

Soft close, thin and quick release seat
Will flush at Eco saving 3/4.5L
Complete with floor fixings
Requires concealed cistern
w 360 x d 560 x h 400mm

Toilet	KL6207CW	£300
Seat	KL6205W	£150
		£450

Compact Close Coupled Toilets



Gloss White Compact Close Coupled Toilet

Reduced projection toilet
Soft close, thin and quick release seat
Will flush at Eco saving 3/4.5L
Complete with floor fixings
Factory fitted cistern and mechanism
w 360 x d 620 x h 395mm (toilet)
w 360 x d 150 x h 385mm (cistern)

Toilet	KL6205CW	£255
Cistern & Mechanism	KL7205CW+	£275
Seat	KL6205W	£150
		£680

Compact Design

Our Kai X compact close coupled toilet, with a projection of 62cm, combines space saving form with all the comfort of a larger model. This original design is a great solution for freeing up space in any smaller bathroom.





NEW





SVELTE

Manufactured in Italy, the beautifully crafted Svelte range combines eclectic style with innovative modern technology for a new sophistication in toilet design.

To achieve a modern look that beautifully complements the Svelte range, pair with our toilet furniture units to streamline the entire space and conceals unaesthetic working parts of cisterns.



Lifetime Guarantee*
Peace of mind



Made in Italy
Designed for the UK



Rimless Design Easy
to clean



Wall Hung p 118
Back to Wall p 118



Wall Hung Toilets



Gloss White Wall Hung Toilet

NEW

Rimless toilet
Soft close seat
Will flush at Eco saving 3/4.5L
Complete with concealed fixings
Requires support frame and cistern
w 360 x d 520 x h 270mm

Toilet	SE6116CW+	£490
Seat	SE6105W	£195
		£685

Back to Wall Toilets



Gloss White Back to Wall Toilet

NEW

Rimless toilet
Soft close seat
Will flush at Eco saving 3/4.5L
Complete with floor fixings
Requires concealed cistern
w 360 x d 520 x h 420mm

Toilet	SE6117CW+	£480
Seat	SE6105W	£195
		£675



All Svelte toilets conform to BS EN 997:2018 Class 2 and BS EN 33:2019
Due to ceramic manufacturing processes all dimensions printed are approximate. The height dimensions for the toilets does not include the seat dimensions.
To find your local retailer please visit www.crosswater.co.uk







KAI S

An effortless fit for any bathroom. Our Kai S range has close coupled toilets, full back to wall or easy to install open backed, to effortlessly fit into any bathroom. The hygienic glaze throughout make these toilets the perfect choice for every modern bathroom.



Lifetime Guarantee*
Peace of mind



Made in Portugal
Designed for the UK



Wall Hung p 122
Back to Wall p 122
Close Coupled p 122



Wall Hung Toilets



Gloss White Wall Hung Toilet

Soft close and quick release seat
Will flush at Eco saving 3/4.5L
Complete with pre-fitted concealed fixings
Factory fitted wall hung fittings
Requires support frame and cistern
w 370 x d 540 x h 282mm

Toilet	KL6306CW	£285
Seat	KL6305W	£145
		£430

Back to Wall Toilets



Gloss White Back to Wall Toilet

Soft close and quick release seat
Will flush at Eco saving 3/4.5L
Complete with floor fixings
Requires concealed cistern
w 370 x d 545 x h 400mm

Toilet	KL6307CW	£235
Seat	KL6305W	£145
		£380

Compact Close Coupled Toilets



Gloss White Compact Close Coupled Toilet

Reduced projection toilet
Soft close and quick release seat
Will flush at Eco saving 3/4.5L
Complete with floor fixings
Factory fitted cistern and mechanism
w 370 x d 620 x h 790mm (toilet)
w 300 x d 160 x h 395mm (cistern)

Toilet	KL6305CW	£250
Cistern & Mechanism	KL7305CW+	£250
Seat	KL6305W	£145
		£645



Gloss White Compact Close Coupled Toilet Open

Reduced projection toilet
Soft close and quick release seat
Will flush at Eco saving 3/4.5L
Complete with floor fixings
Factory fitted cistern and mechanism
w 370 x d 640 x h 790mm (toilet)
w 300 x d 160 x h 395mm (cistern)

Toilet	KL6315CW	£200
Cistern & Mechanism	KL7305CW+	£250
Seat	KL6305W	£145
		£595

Compact Design

Our Kai S compact close coupled toilets, with a projection of 64cm, combines space saving form with all the comfort of a larger model. This original design is a great solution for freeing up space in any smaller bathroom.

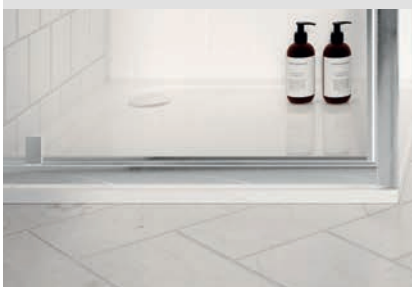







KAI

Our Kai range has close coupled toilets, full back to wall or easy to install open backed, to effortlessly fit into any bathroom. The hygienic glaze throughout make these toilets the perfect choice for every modern bathroom.

A combination of aesthetics and function, our Kai toilets offering a level of design and comfort that combines effortlessly with every modern bathroom.



Lifetime Guarantee*
Peace of mind



Made in Portugal
Designed for the UK

Wall Hung p 126
Back to Wall p 126
Close Coupled p 126



Wall Hung Toilets



Gloss White Wall Hung Toilet

Soft close, thin and quick release seat
Will flush at Eco saving 3/4.5L
Frame fixings supplied with frame
Requires concealed cistern
w 350 x d 530 x h 320mm

Toilet	KL6006CW	£180
Seat	KL6105W	£110
		£290

Back to Wall Toilets



Gloss White Back to Wall Toilet

Soft close, thin and quick release seat
Will flush at Eco saving 3/4.5L
Complete with floor fixings
Requires concealed cistern
w 355 x d 540 x h 400mm

Toilet	KL6007CW	£150
Seat	KL6105W	£110
		£260

Compact Close Coupled Toilets



Gloss White Compact Close Coupled Toilet

Reduced projection toilet
Soft close, thin and quick release seat
Will flush at Eco saving 3/4.5L
Complete with floor fixings
w 365 x d 640 x h 400mm (toilet)
w 365 x d 155 x h 390mm (cistern)

Toilet	KL6005CW	£200
Cistern & Mechanism	KL7005CW+	£155
Seat	KL6105W	£110
		£465

Compact Design

Our Kai compact close coupled toilet, with a projection of 64cm, combines space saving form with all the comfort of a larger model. This original design is a great solution for freeing up space in any smaller bathroom.



All Kai toilets conform to BS EN 997:2018 Class 2 and BS EN 33:2019
Due to ceramic manufacturing processes all dimensions printed are approximate. The height dimensions for the toilets does not include the seat dimensions.
To find your local retailer please visit www.crosswater.co.uk



SUPPORT FRAMES & CISTERNS



2 Year Guarantee*
Peace of mind



Support Frames & Cisterns

Our support frame and cistern range is designed specifically for UK homes, featuring an array of innovative designs and installation features, which is why our products are renowned for excellence in design and quality.

Layout Versatility

Whatever the size or shape of your bathroom, Crosswater fitting systems can be utilised in any bathroom to safely install a toilet that suits your lifestyle. The smart and versatile systems mean that you can take your design aspirations and make them a reality. Easily install a toilet right next door to a shower by having the cistern concealed in a wall. The back-to-wall toilet is perfect for complementing the toilet cisterns when concealed within furniture or a cavity.

Simple Installation

From large new build family bathrooms to modernising a bijou en suite, the ease of installing Crosswater flushing systems ensures that your project runs smoothly. Time and cost effective, frames can be built into a wall cavity or placed in front of a wall using a clever cistern surround. If you want to tile a wall, select a waterproof frame surrounds that can also be tiled. Alternatively, for a completely harmonised bathroom scheme, simply choose a surround to match your Crosswater furniture.



Wall Hung Support Frames

Wall mounted furniture cleverly makes a compact bathroom appear less cluttered and more spacious. Open up the smallest of spaces or enhance larger bathrooms by creating more floor space, which instantly creates the illusion of space. For busy family bathrooms, it is also quicker and easier to clean.

See page 130 for Wall Hung Toilet Support Frames.



Concealed Toilet Cisterns

Create a sense of space and understated hotel style with a concealed cistern, or combine with our toilet furniture units - a modern solution for a clutter-free, designer bathroom. There is a choice of heights to suit where the flush panel is situated, accommodating any constraints of the room.

See page 132 for Concealed Toilet Cisterns



WALL HUNG TOILET SUPPORT FRAMES

0.82m Toilet Frame



0.82m Height Toilet Frame

NEW

- Dual flush
- Top & front flush
- Compatible with our wide range of flush plates
- Epoxy power coated steel frame, tested to take up to 400kg weight
- Large feet for easy rear fixing (designed for UK timber floor)
- Supplied complete with all fittings for installation
- Easy install wall brackets for vertical or horizontal fixing
- Maximum supply pressure 6 bar

WCF82X50+2

£415



0.98m Toilet Frame



0.98m Height Toilet Frame

NEW

- Dual flush
- Front flush only
- Compatible with our wide range of flush plates
- Epoxy power coated steel frame, tested to take up to 400kg weight
- Large feet for easy rear fixing (designed for UK timber floor)
- Supplied complete with all fittings for installation
- Easy install wall brackets for vertical or horizontal fixing
- Maximum supply pressure 6 bar

WCF98X50+2

£430

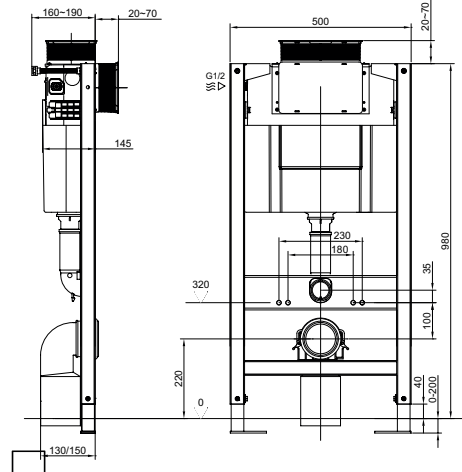
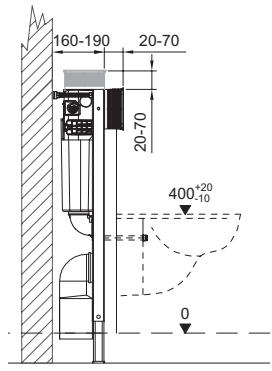
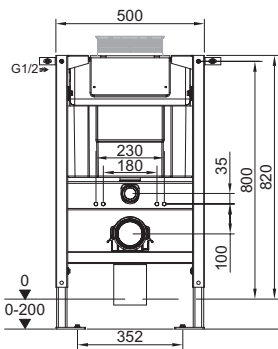

1.12m Toilet Frame



1.12m Height Toilet Frame

NEW

- Dual flush
- Front flush only
- Compatible with our wide range of flush plates
- Epoxy power coated steel frame, tested to take up to 400kg weight
- Large feet for easy rear fixing (designed for UK timber floor)
- Supplied complete with all fittings for installation
- Easy install wall brackets for vertical or horizontal fixing
- Maximum supply pressure 6 bar

WCF118X50+2

£425



Ultra Slim 1.14m Toilet Frame



Ultra Slim 1.14m Height Toilet Frame

NEW

- Dual flush
- Front flush only
- Compatible with our wide range of flush plates
- Epoxy power coated steel frame, tested to take up to 400kg weight
- Large feet for easy rear fixing (designed for UK timber floor)
- Supplied complete with all fittings for installation
- Easy install wall brackets for vertical or horizontal fixing
- Maximum supply pressure 6 bar

WCF118X50-VS+2

£445

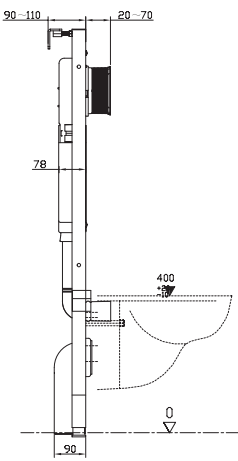
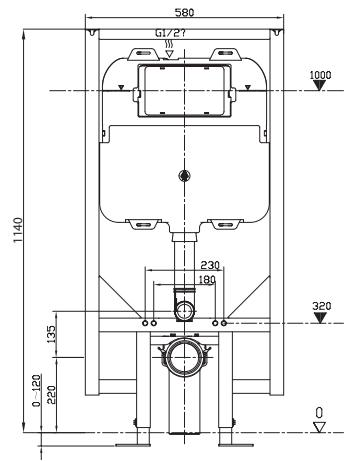
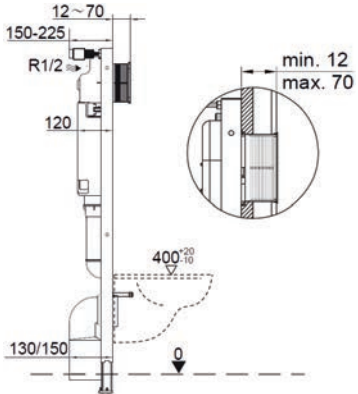
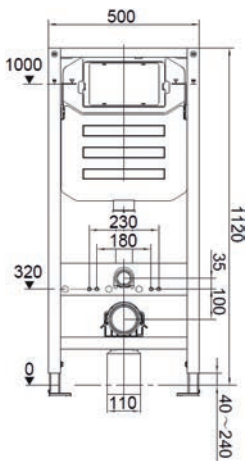

Pair with our Wall Mounted Toilets

Wall mounted furniture cleverly makes a compact bathroom appear less cluttered and more spacious. There is a range of frame sizes to suit larger rooms and a ultra slim designs for those seeking a more sleek, minimalistic look.

Our wall hung toilet support frames feature:

- Epoxy power coated steel frame, tested to take up to 400kg weight
- Large feet for easy rear fixing (specially designed for UK timber floor)
- Supplied complete with all fittings for installation
- Adjustable feet with rubber sound deadening pads
- Full UK specification to Class 2
- Easy install wall brackets for vertical or horizontal fixing

Space Saving Solution

If you are looking to save even more space, or if you have a restricted wall cavity, our Ultra Slim 1.14m Height Toilet Frame and wall cistern offer the perfect solution.

Including all of the features and benefits of the standard but with a reduced depth, this option is ideal for bathrooms where space is limited or you are planing on a tiled surround.



Ultra Slim 1.14m Height Toilet
Frame WCF118X50-VS+2



Height Variation

For toilets fitted underneath a window or perhaps an awkward space, flush function plates can operate from three different heights regardless of the support frame height.



0.82m

0.98m

1.12m



CONCEALED TOILET CISTERNS

Standard Height Concealed Cistern



0.46m Height Concealed Cistern

NEW

- Dual flush
- Top & front flush
- Compatible with our wide range of flush plates
- UK sized inlet and outlet pipe work
- Water saving dual flush cistern – factory set at 6/3 litre adjustable to 4.5/3 litre
- Simple mechanical or cable connection method to ensure high performance
- Complete with accessible isolating valve
- Maximum supply pressure 6 bar
- w 404 x d 465 x h 140mm

WCC47X46+2

£175

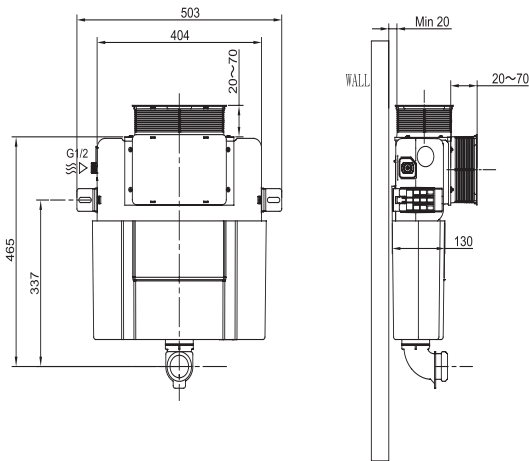

Slimline Concealed Cistern



Slimline Concealed Cistern

- Dual flush
- UK sized inlet and outlet pipe work
- Water saving dual flush cistern – factory set at 6/3 litre adjustable to 4.5/3 litre
- Simple mechanical or cable connection method to ensure high performance
- Complete with accessible isolating valve
- Maximum supply pressure 6 bar
- w 390 x d 135 x h 315mm

WCC33X31+

£125

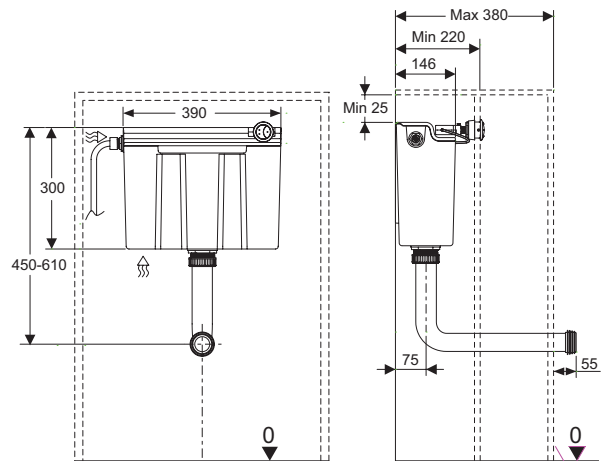

Taller Concealed Cistern



0.53m Height Concealed Cistern

NEW

- Dual flush
- Top & front flush
- Compatible with our wide range of flush plates
- UK sized inlet and outlet pipe work
- Water saving dual flush cistern – factory set at 6/3 litre adjustable to 4.5/3 litre
- Simple mechanical or cable connection method to ensure high performance
- Complete with accessible isolating valve
- Maximum supply pressure 6 bar
- w 480 x d 78 x h 535mm

WCC57X46+2

£250

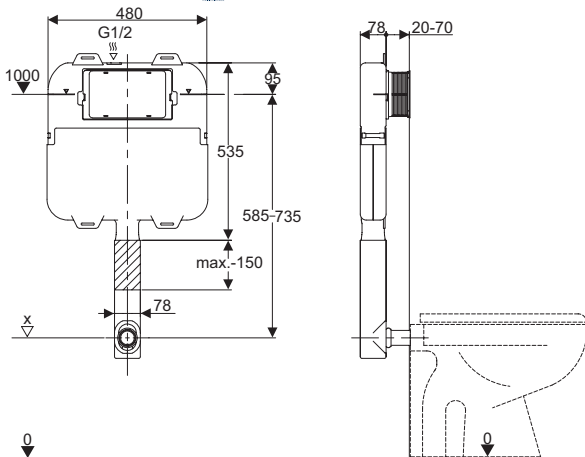

Create a Clutter Free Bathroom

Create a sense of space and understated hotel style with a concealed cistern. There is a choice of heights to suit where the flush panel is situated, accommodating any constraints of the room.

Our concealed toilet cisterns feature:

- UK sized inlet and outlet pipe work
- Water saving dual flush cistern – factory set at 6/3 litre adjustable to 4.5/3 litre
- Simple mechanical or cable connection method to ensure high performance
- Complete with accessible isolating valve
- Compatible with our wide selection of flush plates



FLUSH PLATES



2 Year Guarantee*
Peace of mind

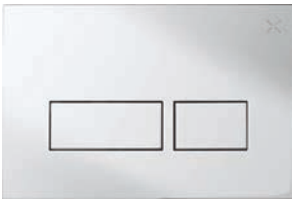

MPRO

**Chrome**

Mechanical operation
ABS
w 236 x h 152mm

TEFLUSHC+ £85

**Matt Black**

Mechanical operation
ABS
w 236 x h 152mm

PROFLUSHB £85

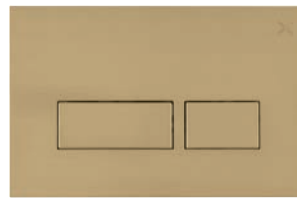
**Brushed Brass**

Mechanical operation
ABS
w 236 x h 152mm

PROFLUSHF £145

**Brushed Stainless Steel Effect**

Mechanical operation
ABS
w 236 x h 152mm

PROFLUSHV+ £145

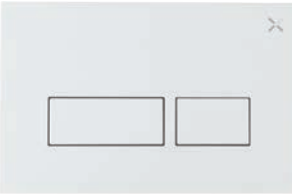
**Matt White**

Mechanical operation
ABS
w 236 x h 152mm

PROFLUSHMW £85

ARENA

**Chrome**

Mechanical operation
ABS
w 236 x h 152mm

ANFLUSHC £85

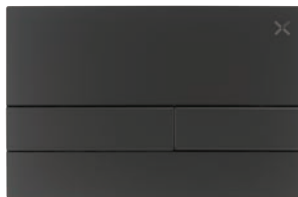
**Matt Black**

Mechanical operation
ABS
w 236 x h 152mm

ANFLUSHB £85

**Brushed Brass**

Mechanical operation
ABS
w 236 x h 152mm

ANFLUSHF £145

**Brushed Stainless Steel Effect**

Mechanical operation
ABS
w 236 x h 152mm

ANFLUSHV £145

CENTRAL

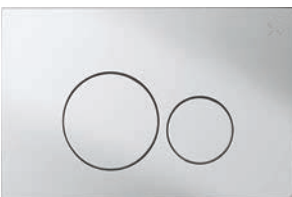
**Chrome**

Mechanical operation
ABS
w 236 x h 152mm

CEFLUSHC+ £85

**Ice White Glass**

Mechanical operation
Thermal tempered glass
w 236 x h 152mm

FLUSHIW £275

Cleverly designed for your bathroom

Crosswater flush plates complement any bathroom design. We offer a wide range of finishes to beautifully match your brassware, toilet and furniture.

Our flush plates are:

- Easy to fit
- Dual flush - including eco flush
- Smooth yet positive operation
- Manufactured from high impact, tough ABS or thermal tempered glass
- Actuation force 20NM
- Compatible with our toilet frames and concealed cisterns

There is no need to worry about maintenance as all cistern parts can be accessed by simply removing the flush plate.

The dual flush technology allows you to reduce your water usage by up to 40%. Press the large button to flush with the entire water volume, or the smaller button for an Eco flush (reduced 3 litre volume).



TOILET FURNITURE UNITS



10 Year Guarantee*
Peace of mind





American Walnut

Requires some on site assembly
w 545 x d 225 x 920mm

SP5492AW £305



Grey Ash

Requires some on site assembly
w 545 x d 225 x 920mm

SP5492GA £305



NEW

Castilla Oak

Requires some on site assembly
w 545 x d 225 x 920mm

SP5492CO £305



Modern Oak

Requires some on site assembly
w 545 x d 225 x 920mm

SP5492MO £245



Windsor Oak

Requires some on site assembly
w 545 x d 225 x 920mm

SP5492WO £305



Steelwood

Requires some on site assembly
w 545 x d 225 x 920mm

SP5492ST+ £230



Grey Oak

Requires some on site assembly
w 545 x d 225 x 920mm

KL15492GO £195



Matt Black

Requires some on site assembly
w 545 x d 225 x 920mm

SP5492BM £255



Portland Grey Matt

Requires some on site assembly
w 545 x d 225 x 920mm

SP5492PGM £360



Storm Grey Matt

Requires some on site assembly
w 545 x d 225 x 920mm

SP5492SG £255



NEW

Cashmere Matt

Requires some on site assembly
w 545 x d 225 x 920mm

SP5492CM £255



NEW

Matt White

Requires some on site assembly
w 545 x d 225 x 920mm

SP5492WM £255



NEW

Onyx Black

Requires some on site assembly
w 545 x d 225 x 920mm

SP5492OB £255



Pure White Gloss

w 545 x d 225 x 920mm

SP5492WG+ £365



White Gloss

Requires some on site assembly
w 545 x d 225 x 920mm

SP5492WG £270



Kai Grey Gloss

Requires some on site assembly
w 545 x d 225 x 920mm

KL15492GG £220



Kai White Gloss

Requires some on site assembly
w 545 x d 225 x 920mm

KL15492WG £195

Perfect for any bathroom

All our toilet furniture units are suitable for use with toilet frame WCF82X50+ and concealed cisterns WCC47X46+2 and WCC33X31+.

Our slimline floor units are supplied with uncut fascia, removable top and adjustable feet.



MIRRORS & CABINETS



5 Year Guarantee*
Peace of mind



Illuminated Mirrors

The ultimate bathroom essential to assist with daily routines, our range of mirrors give you plenty of extra features.

5mm mirror glass

PVC film backing safety glass complying to BS EN 6206 1981 that avoids dangerous shards being created in case of an accident. A special treatment is also applied to the mirror edge that prevents the mirror edges becoming discoloured.



IP44 Class 1 rated

All our mirrors are IP44, Class 1 rated and suitable for installation in Zones 2 and 3 of a bath or shower room. Mirrors conform to BS EN 60598-2-1. See page 175 for more information on electrical safety and installation.



LED lighting

Providing superb function with fabulous decorative style, all mirrors feature high luminosity, low energy consuming LED lighting. See product details for light temperature.



Charging socket

Selected models come with a charging socket for easy and safe recharging of shavers or toothbrushes.

Heated demister pad

Most of our mirrors are equipped with demisting pads that heat the mirror to a few degrees above room temperature within 2-3 minutes, preventing the mirror from misting. The demisting will spread approx. 10-20% further than the pad.



Touch controls

Selected Crosswater mirrors are equipped with a one touch control for easy on/off, light temperature change and dimming.



No touch infrared on/off switch

Selected Crosswater mirrors are equipped with a no touch infrared on/off sensor situated on the side of the mirror.

Mirrored Cabinets

Store away those everyday bathroom essentials discreetly and safely with our range of stylish mirrored cabinets.

Double sided mirrored doors

Head and shoulders height viewing, enabling you to use the mirror even when the door is open. The mirror's edges are sealed to minimise the possibility of moisture damage.



IP44 Class 1 rated & CE approved

All our mirrored cabinets are IP44, Class 1 rated and CE approved. See page 175 for more information on electrical safety and installation.



Charging socket

Our cabinets come with an internal charging socket for easy and safe recharging of shavers or toothbrushes.

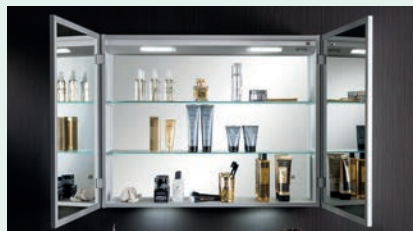

Continuous shelf height adjustment

Intelligent shelf height adjustment allows shelves to be adjusted to any height, without unsightly drilled holes.

LED lighting

Near natural truly practical low energy light source. No-flicker instant on and off illumination. Low energy consuming LED lighting. See product details for light temperature.



No touch infrared on/off switch

High-tech sensor switch, so no unsightly pull cord, discreetly positioned underneath the cabinet for simple use.

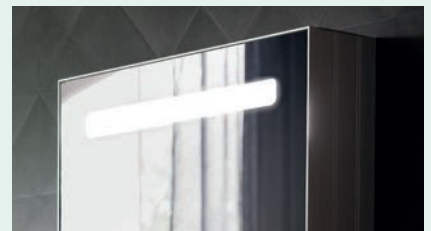

Aluminium carcass

Fully rigid, strong, easy to maintain, anodised aluminium carcass, perfect for use in humid bathroom conditions.

Important information

Mirrors must be mounted so that the sensor switch is a minimum of 150mm from an adjacent wall or obstruction to ensure function of the sensor switch.

If a mirror is mounted portrait, the sensor is located on the bottom right hand edge of the mirror. If mounted landscape, the sensor switch is located on the bottom left hand corner.

All mirrors and cabinets are IP44, Class 1 rated and suitable for installation in Zones 2 and 3 of a bath or shower room, see page 175 for more information on electrical safety and installation.



ARTIST®



5 Year Guarantee*
Peace of mind





NEW

Artist Back Lit Mirror

Ambient behind glass perimeter LED lighting
 No touch PIR sensor on/off switch
 Heated demister pad 16w
 5mm mirror glass with safety film backing
 IP44 Class 1 rated
 Landscape or portrait hanging
 w 800 x d 30 x h 600mm

ART6080

£375



NEW

Artist Back Lit Mirror

Ambient behind glass perimeter LED lighting
 No touch PIR sensor on/off switch
 Heated demister pad 25w
 5mm mirror glass with safety film backing
 IP44 Class 1 rated
 Landscape or portrait hanging
 w 1000 x d 30 x h 600mm

ART60100

£435

The perfect partner for our Artist furniture

Artist mirrors have been specially designed to pair with the shape of our Artist furniture collection. Available in four finishes, compatible with a range of basins and brassware, this collection can be styled to your taste. See page 8 to see the full range.



GLIDE II



5 Year Guarantee*
Peace of mind





Glide II Ambient Lit Mirror

Touch controls to adjust brightness and colour temperature
 LED lighting
 Charging/shaver socket EN61558-2-5
 Heated demister pad 310 x 450mm 21w
 5mm mirror glass with safety film backing
 IP44 Class 1 rated
 w 500 x d 35 x h 800mm

GL5080

£390



Glide II Ambient Lit Mirror

Touch controls to adjust brightness and colour temperature
 LED lighting
 Charging/shaver socket EN61558-2-5
 Heated demister pad 310 x 450mm 21w
 5mm mirror glass with safety film backing
 IP44 Class 1 rated
 w 800 x d 35 x h 600mm

GL6080

£420



Glide II Ambient Lit Mirror

Touch controls to adjust brightness and colour temperature
 LED lighting
 Charging/shaver socket EN61558-2-5
 Heated demister pad 310 x 450mm 21w
 5mm mirror glass with safety film backing
 IP44 Class 1 rated
 w 1000 x d 35 x h 600mm

GL10060

£480

Create your perfect bathroom ambiance

Glide II mirrors feature the latest LED technology, allowing you to change the colour temperature of the mirror from warm white (3000K) to daylight (6000K) and every shade in-between. The demisting feature and charging socket for your toothbrush or a shaver completes this lovely bathroom mirror.



Warm white

Cool white

Daylight

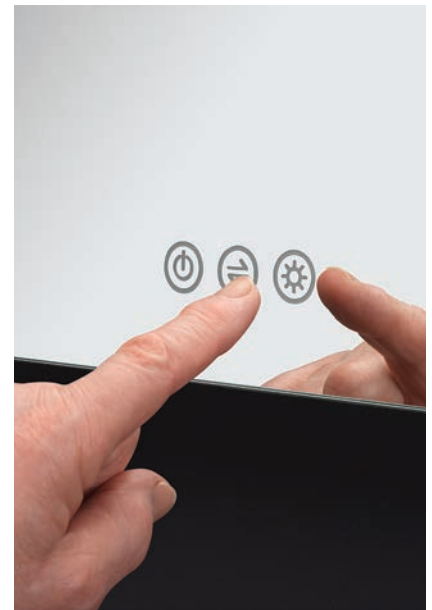

SVELTE



5 Year Guarantee*
Peace of mind





Svelte Illuminated Mirror

Touch controls to adjust brightness and colour temperature
 LED lighting
 Heated demister pad 310 x 450mm 21w
 5mm mirror glass with safety film backing
 IP44 Class 1 rated
 Landscape or portrait hanging
 w 500 x d 35 x h 800mm

SE5080

£440



Svelte Illuminated Mirror

Touch controls to adjust brightness and colour temperature
 LED lighting
 Heated demister pad 310 x 450mm 21w
 5mm mirror glass with safety film backing
 IP44 Class 1 rated
 w 600 x d 35 x h 600mm

SE6060

£420



Svelte Illuminated Mirror

Touch controls to adjust brightness and colour temperature
 LED lighting
 Heated demister pad 310 x 450mm 21w
 5mm mirror glass with safety film backing
 IP44 Class 1 rated
 Landscape hanging only
 w 1200 x d 35 x h 700mm

SE12070

£595

Change your lighting to suit your mood

Svelte mirrors blend form and function with elegant design. The perimeter LED lighting allows you to change the colour temperature of your mirror between warm white (3000K) to daylight (6000K). Additionally, the mirror can be dimmed to suit your mood.

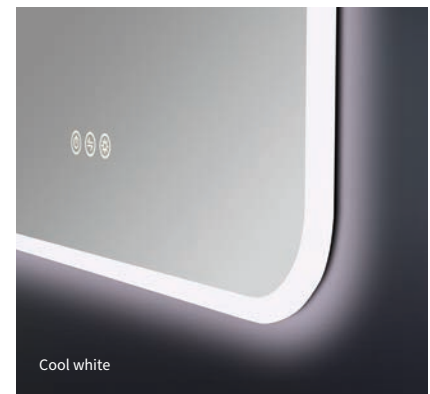

INFINITY



5 Year Guarantee*
Peace of mind





Infinity Non Lit Mirror

No lighting
5mm mirror glass with safety film backing
Ø 500 x d 8mm

IF5050

£195



Infinity Illuminated Mirror

Touch controls to adjust light temperature
Adjustable light temperature from 3000K to 6000K
LED lighting
5mm mirror glass with safety film backing
IP44 Class 1 rated
Ø 500 x d 8mm

IF_MIRROR

£290



NEW

Infinity Illuminated Mirror

Touch controls to adjust light temperature
Adjustable light temperature from 3000K to 6000K
LED lighting
Heated demister pad 300 x 200mm 11w
5mm mirror glass with safety film backing
IP44 Class 1 rated
Ø 600 x d 30mm

IF_MIRROR60

£385



NEW

Infinity Illuminated Mirror

Touch controls to adjust light temperature
Adjustable light temperature from 3000K to 6000K
LED lighting
Heated demister pad 350 x 250mm 16w
5mm mirror glass with safety film backing
IP44 Class 1 rated
Ø 700 x d 30mm

IF_MIRROR70

£435



NEW

Infinity Illuminated Mirror

Touch controls to adjust light temperature
Adjustable light temperature from 3000K to 6000K
LED lighting
Heated demister pad 310 x 450mm 21w
5mm mirror glass with safety film backing
IP44 Class 1 rated
Ø 800 x d 30mm

IF_MIRROR80

£460

Control your lighting at a touch of a button

The perimeter LED lighting of our Infinity illuminated mirrors allows you to change the colour temperature of your mirror between warm white (3000K) to daylight (6000K) with one touch. Infinity Ø 500mm is also available in a non-lit version.



DUNE



5 Year Guarantee*
Peace of mind





Dune Illuminated Mirror

Touch controls to adjust light temperature
 LED lighting
 Heated demister pad 310 x 450mm 30w
 5mm mirror glass with safety film backing
 IP44 Class 1 rated
 Portrait hanging only
 w 400 x d 34 x h 600mm

DN4060

£360



Dune Illuminated Mirror

Touch controls to adjust light temperature
 LED lighting
 Heated demister pad 310 x 450mm 30w
 5mm mirror glass with safety film backing
 IP44 Class 1 rated
 Portrait hanging only
 w 500 x d 34 x h 800mm

DN5080

£450

Beautiful and practical illuminated mirrors

Dune mirrors feature the latest LED technology, allowing you to change the colour temperature of the mirror from warm white (3000K) to daylight (6400K) at the touch of a button. The demisting feature completes this practical bathroom mirror.

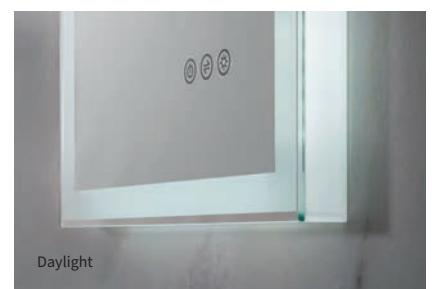
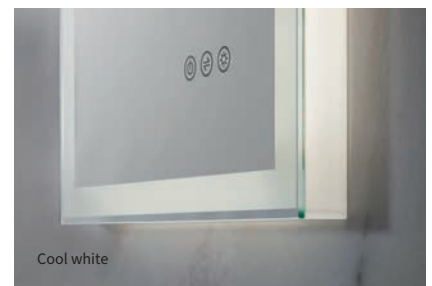

MPRO



5 Year Guarantee*
Peace of mind





MPRO Lit Mirror

PIR sensor on/off switch
 LED lighting - daylight 6400K
 Heated demister pad 310 x 450mm 30w
 5mm mirror glass with safety film backing
 IP44 Class 1 rated
 Portrait or landscape hanging
 w 600 x d 32 x h 800mm

MP6080V

£430

Control your lighting with a wave of your hand

Contemporary up-to-date styling featuring hand-finished brushed aluminium pencil style frame and perimeter LED lighting. Active the lights when you need them by waving your hand over the PIR sensor located on the frame.





5 Year Guarantee*
Peace of mind



Elite Lit Mirror

PIR sensor on/off switch
84 x 5W LEDs - daylight 6400K
Heated demister pad 310 x 450mm 22w
5mm mirror glass with safety film backing EN6206.1961
IP44 Class 1 rated
Portrait or landscape hanging
w 600 x d 32 x h 800mm

ME8050B

£370

Crystal clear reflection with an array of features

Elite mirrors feature a no-touch on/off switch as well as heated de-misting pads which turn on in conjunction with the energy saving LED lights and gently warm just above room temperature to cleverly remove mist.

RADIANCE



5 Year Guarantee*
Peace of mind

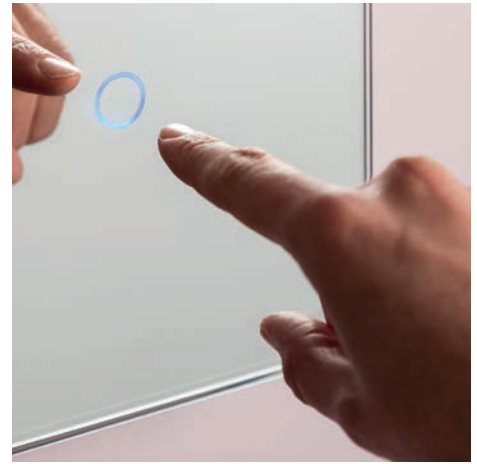

Radiance Ambient Lit Mirror

Touch control on/off switch
LED lighting through mirror and behind glass perimeter
Daylight 6400k
5mm mirror glass with safety film backing EN6206.1961
IP44 Class 1 rated
w 800 x d 43 x h 600mm

MEA6080

£545



IMAGE



5 Year Guarantee*
Peace of mind





Image Mirrored Cabinet

Double sided mirror door with soft close hinges
 PIR sensor on/off switch
 Adjustable light temperature from warm white daylight
 Cool ambient under cabinet and internal LED lighting
 Internal mirrored back panel - easy to clean
 3 height adjustable 5mm thick toughened safety glass shelves
 Internal charging/shaver socket EN61558-2-5
 Fully IP44 rated & CE approved
 A energy rating
 w 505 x d 120 x h 750mm

IG5070

£815



Image Mirrored Cabinet

Double sided mirror doors with soft close hinges
 PIR sensor on/off switch
 Adjustable light temperature from warm white daylight
 Cool ambient under cabinet and internal LED lighting
 Internal mirrored back panel - easy to clean
 3 height adjustable 5mm thick toughened safety glass shelves
 Internal charging/shaver socket EN61558-2-5
 Fully IP44 rated & CE approved
 A energy rating
 w 705 x d 120 x h 750mm

IG7070

£1095



Image Mirrored Cabinet

Double sided mirror doors with soft close hinges
 PIR sensor on/off switch
 Adjustable light temperature from warm white daylight
 Cool ambient under cabinet and internal LED lighting
 Internal mirrored back panel - easy to clean
 3 height adjustable 5mm thick toughened safety glass shelves
 Internal charging/shaver socket EN61558-2-5
 Fully IP44 rated & CE approved
 A energy rating
 w 905 x d 120 x h 750mm

IG9070

£1125

Beautiful outside, intelligent inside

Our Image mirrored cabinets sets new standards with innovative technology, classic design and proportions which contain ample space for all your storage needs. Featuring double-sided fully mirrored doors for comfortable and expansive head and shoulders viewing. Full-width overhead LED light canopy provides outstanding brightness that can be changed from warm white (3000K) to daylight (6000K) to suit your mood. An extra LED light source illuminates the tap and basin on the underside of the cabinet

Open the cabinet to find height-adjustable safety glass shelves with a stunning fully mirrored back. Additionally, LED lighting appears on each interior side of the cabinet to illuminate all your favourite items. As well as a charging socket for shaver or toothbrush.



ALLURE



5 Year Guarantee*
Peace of mind





Allure Mirrored Cabinet

Double sided mirror door with patented door hinge design
 Heated demister pad
 Finger print free aluminium carcass
 In-door and under cabinet LED lighting – 6000K
 PIR sensor on/off switch
 Internal LED lighting – door activated 6000K
 Internal mirrored back panel - easy to clean
 2 height adjustable 5mm thick toughened safety glass shelves
 Concealed and adjustable hanging system
 Internal charging/shaver socket EN61558-2-5
 Fully IP44 rated & CE approved
 A energy rating
 w 500 x d 125 x h 700mm

AL5070AL

£985

Make steamy mirrors a thing of the past

Allure mirrors feature our innovative heated mirror doors, heating to a few degrees above room temperature within 2-3 minutes, preventing them from misting in even the steamiest of bathrooms.

Beautifully illuminated from all angles, Allure features the next generation of LED lighting, offering superior performance at the lowest possible energy consumption. Plentiful storage space is provided behind the mirrored door, which conceal the cabinet's patented hinge technology, complemented by a mirrored back panel.





TOWEL WARMERS



- Artist p 160
- Air p 161
- MPRO Electric p 162
- MPRO p 164
- Infinity p 166
- Wedge p 167
- Celeste p 168
- Kai p 170
- Towel Warmer Valves p 172
- Summer Heating Elements p 173



ARTIST



15 Year Guarantee*
Peace of mind



Perfect Match For Artist Furniture

Specially designed to complement our Artist furniture units in colour and style. The optional solid oak shelf matches the solid oak Artist furniture worktop.



NEW
Onyx Black

BTU 1982 / Watts 581
Dual fuel element available*
w 400 x h 1240mm

ART40X1240OB £645



NEW
Cashmere Matt

BTU 1982 / Watts 581
Dual fuel element available*
w 400 x h 1240mm

ART40X1240CM £645



NEW
Storm Grey

BTU 1982 / Watts 581
Dual fuel element available*
w 400 x h 1240mm

ART40X1240SG £645



NEW
Matt White

BTU 1982 / Watts 581
Dual fuel element available*
w 400 x h 1240mm

ART40X1240MW £645



Pier Chrome Corner TRV†
RADVTRVC1C £85



Matt White Corner Valve
RADCORNERMW £130



Optional FSC Solid Oak Shelf
Simply slot into position where you prefer
ARTSHELFOAK £130



15 Year Guarantee*
Peace of mind



Innovative Design For High Heat Output

Air rails feature innovative manufacturing technology that injects air at very high pressure into the cross rails, this expands the cross rails to allow more hot water to circulate to generate excellent heat output.



NEW

Metallic Black

BTU 1514 / Watts 444
Dual fuel element available*
w 500 x h 1150mm

AR50X1150MB

£460



NEW

Metallic Black

BTU 2197 / Watts 644
Dual fuel element available*
w 500 x h 1630mm

AR50X1630MB

£625



NEW

Soft White Matt

BTU 1514 / Watts 444
Dual fuel element available*
w 500 x h 1150mm

AR50X1150SW

£460



NEW

Soft White Matt

BTU 2197 / Watts 644
Dual fuel element available*
w 500 x h 1630mm

AR50X1630SW

£625



Matt Black Angled TRV

RADVTRVA1B

£85



Matt Black Corner TRV

RADVTRVC1B

£85



Pier Chrome Angled TRV†

RADVTRVA1C

£85



Pier Chrome Corner TRV†

RADVTRVC1C

£85



M PRO ELECTRIC



15 Year Guarantee*
Peace of mind



Heated Towels All Year Round

MPRO All electric towel warmers are ideal for bathroom projects where installation on the central heating system is not possible. Oil filled and 100% pressure, leak and function tested at our factory.

Oil filled means better and more even heat distribution throughout the entire rail, excellent heat retention so less energy is required to top up temperatures in your room. Once the timer period has ended these rails will continue to gently radiate heat and keep the room comfortable because the oil inside is designed to cool slowly.

Great for the summer time when the central heating is off but cosy warm towels required.

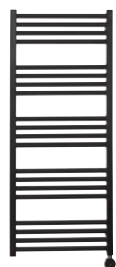

NEW

All Electric Matt Black

400W
Class 1 IPX5
w 480 x h 1140mm

MP48X1140MBELEC

£570



NEW

All Electric Matt Black

600W
Class 1 IPX5
w 480 x h 1380mm

MP48X1380MBELEC

£660



NEW

All Electric Matt White

400W
Class 1 IPX5
w 480 x h 1140mm

MP48X1140MWELEC

£570



NEW

All Electric Matt White

600W
Class 1 IPX5
w 480 x h 1380mm

MP48X1380MWELEC

£660



NEW

All Electric Brushed Brass Effect

400W
Class 1 IPX5
w 480 x h 1140mm

MP48X1140FELEC

£690

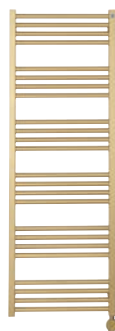

NEW

All Electric Brushed Brass Effect

600W
Class 1 IPX5
w 480 x h 1380mm

MP48X1380FELEC

£750

Why Choose Electric?

Our MPRO Electric towel warmers are supplied with a control dial, instead of a traditional valve, which includes innovative features:

- 5 temperature settings ranging from 30°C to 60°C.
- An electronic temperature sensor that guarantees precise temperature control
- Illuminated LED indicators display the set temperature level and the status of the heating
- Dryer/Boost on demand function allows the setting of a higher heating power for two hours, after which the element returns to the previous setting
- In the event of a power failure the element remembers the previous settings therefore making it suitable for connection to external timers

You can rely on the safety of our MPRO Electric towel warmers:

- The element is equipped with frost protection and double protection against overheating
- The display shows warning indicators in case of malfunction
- An active safety feature in case the rail runs dry
- Low power consumption in a standby mode



Boost/
dry function

Temperature

LED indicators

On/off



MPRO



15 Year Guarantee*
Peace of mind

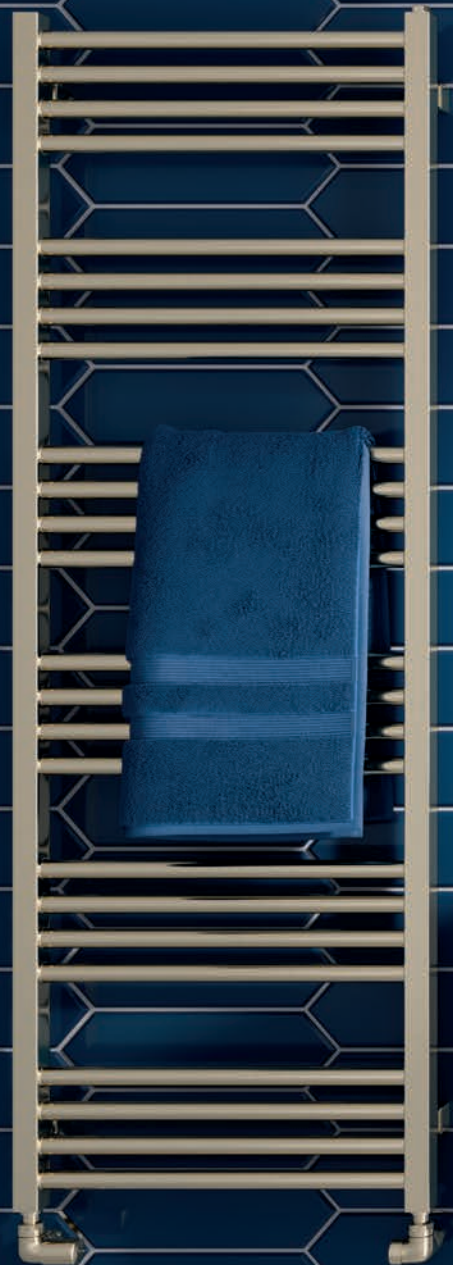

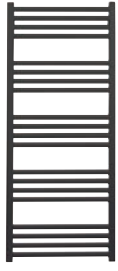

Matt Black

BTU 1607 / Watts 471
Dual fuel element available*
w 480 x h 1140mm

MP48X1140MB

£445



Matt Black

BTU 1938 / Watts 568
Dual fuel element available*
w 480 x h 1380mm

MP48X1380MB

£495



Matt White

BTU 1607 / Watts 471
Dual fuel element available*
w 480 x h 1140mm

MP48X1140MW

£445



Matt White

BTU 1938 / Watts 568
Dual fuel element available*
w 480 x h 1380mm

MP48X1380MW

£495



Brushed Brass Effect

BTU 1607 / Watts 471
Dual fuel element available*
w 480 x h 1140mm

MP48X1140F

£495



Brushed Brass Effect

BTU 1938 / Watts 568
Dual fuel element available*
w 480 x h 1380mm

MP48X13800F

£570



Matt Black Angled TRV

RADVTRVA1B

£85



Matt Black Corner TRV

RADVTRVC1B

£85



Matt White Corner Valve

RADCORNERMW

£130



Brushed Brass Effect Corner Valve

RADCORNERF

£225

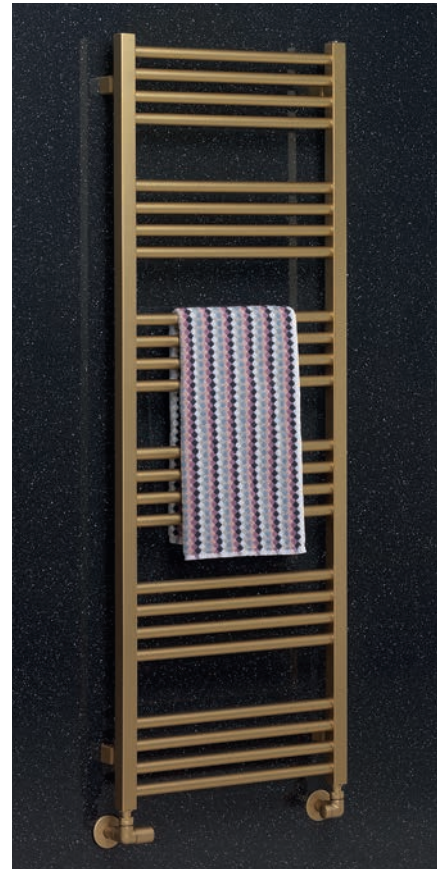

INFINITY



5 Year Guarantee*
Chrome finish



15 Year Guarantee*
Matt Black finish



Matt Black

BTU 2512 / Watts 586
Dual fuel element available*
w 500 x h 1228mm

IF50X122B

£490



Matt Black

BTU 3675 / Watts 861
Dual fuel element available*
w 500 x h 1813mm

IF50X181B

£555



Chrome

BTU 1683 / Watts 393
Dual fuel element available*
w 500 x h 1228mm

IF50X122C

£650



Chrome

BTU 3675 / Watts 861
Dual fuel element available*
w 500 x h 1813mm

IF50X181C

£775



Matt Black Angled TRV

RADVTRVA1B

£85



Matt Black Corner TRV

RADVTRVC1B

£85



Pier Chrome Angled TRV†

RADVTRVA1C

£85



Pier Chrome Corner TRV†

RADVTRVC1C

£85

WEDGE



15 Year Guarantee*
Peace of mind



Metallic Black

BTU 1385 / Watts 406
Dual fuel element available*
w 500 x h 1096mm

WD50X109MB

£375



Soft White Matt

BTU 1385 / Watts 406
Dual fuel element available*
w 500 x h 1096mm

WD50X109SW

£375



Matt White Corner Valve

RADCORNERMW

£130



Kai Anthracite Angled TRV†

RADVTRVAA

£85



Kai Anthracite Corner TRV†

RADVTRVCA

£85



Pier Chrome Angled TRV†

RADVTRVA1C

£85



Pier Chrome Corner TRV†

RADVTRVC1C

£85



CELESTE



15 Year Guarantee*
Peace of mind



Metallic Black

BTU 1887 / Watts 553
Dual fuel element available*
w 500 x h 1100mm

CL50X111MB

£620



Soft White Matt

BTU 1887 / Watts 553
Dual fuel element available*
w 500 x h 1100mm

CL50X111SW

£620



Matt White Corner Valve

RADCORNERMW

£130



Matt Black Angled TRV

RADVTRVA1B

£85



Matt Black Corner TRV

RADVTRVC1B

£85



Pier Chrome Angled TRV†

RADVTRVA1C

£85



Round Chrome Corner Valve

RADVVC1

£95



KAI



5 Year Guarantee*
Chrome finish



15 Year Guarantee*
Anthracite finish





Chrome

BTU 860 / Watts: 203
Dual fuel element available*
w 500 x h 800mm

KL50X80C **£125**



Chrome

BTU 1103 / Watts: 259
Dual fuel element available*
w 500 x h 1000mm

KL50X100C **£165**



Chrome

BTU 1341 / Watts: 315
Dual fuel element available*
w 500 x h 1200mm

KL50X120C **£195**



Chrome

BTU 1799 / Watts: 420
Dual fuel element available*
w 500 x h 1600mm

KL50X160C **£240**



Anthracite

BTU 1270 / Watts: 300
Dual fuel element available*
w 500 x h 800mm

KL50X80A **£105**



Anthracite

BTU 1867 / Watts: 391
Dual fuel element available*
w 500 x h 1000mm

KL50X100A **£125**



Anthracite

BTU 2027 / Watts: 478
Dual fuel element available*
w 500 x h 1200mm

KL50X120A **£165**



Anthracite

BTU 2173 / Watts: 638
Dual fuel element available*
w 500 x h 1600mm

KL50X160A **£200**



Kai Anthracite Corner TRV†

RADVTRVCA **£85**



Anthracite Corner Valve

RADVC1A **£75**



Kai Anthracite Angled TRV†

RADVTRVAA **£85**



Anthracite Angled Valve

RADVA1A **£50**



Pier Chrome Angled TRV†

RADVTRVA1C **£85**



Round Chrome Corner Valve

RADVC1 **£95**



Round Angled Valve

RADVA1 **£60**



TOWEL WARMER VALVES



5 Year Guarantee*
Chrome finish



15 Year Guarantee*
Non chrome finishes



These radiator valves are suitable for all Crosswater towel warmers, except for MPRO Electric models.

Thermostatic Valves



Matt Black Angled TRV

Approved to EN215

RADVTRVA1B

£85



Matt Black Corner TRV

Approved to EN215

RADVTRVC1B

£85



Kai Anthracite Corner TRV†

Approved to EN215

RADVTRVCA

£85



Kai Anthracite Angled TRV†

Approved to EN215

RADVTRVAA

£85



Pier Chrome 15mm Angled TRV†

Approved to EN215

RADVTRVA1C

£85



Pier Chrome 15mm Straight TRV†

Approved to EN215

RADVTRVS1C

£85



Pier Chrome 15mm Corner TRV†

Approved to EN215

RADVTRVC1C

£85

Manual Valves



Anthracite Corner Valve

Supplied with lockshield

RADVC1A

£75



Anthracite Angled Valve

Supplied with lockshield

RADVA1A

£50



Matt White Corner Valve

Supplied with lockshield

RADCORNERMW

£130



Brushed Brass Effect Corner Valve

Supplied with lockshield

RADCORNERF

£225



Round Chrome Corner Valve

Supplied with lockshield

RADVC1

£95



Round Angled Valve

Supplied with lockshield

RADVA1

£60



Square Angled Valve

Supplied with lockshield

RADVA2

£85

SUMMER HEATING ELEMENTS



Electric Element

Supplied with T Piece

IP54 rated

These elements can be used in an all electric installation, we do not offer this service.

300w	RADX350	£115
600w	RADX700	£130

Also known as dual fuel or dual energy. Connected to a central heating circuit and including an electrical element that allows operation in summer months when the central heating is not in use.

All Crosswater towel rails are suitable for use with a summer heating element, except MPRO Electric models. Refer to pages 170 for wattage required per model.

Important Note

Please refer to the bathroom zone diagram when using electrical components within the bathroom environment, see page 171. The summer element is equipped with a thermal fuse that will cut out at 65°C, with a total shut down safety setting at 78°C.

These elements are suitable for all Crosswater towel warmers, where an element can be fitted. Heating elements comply with BS EN60335-2-73:2003



Technical Information - Towel Warmers

Code	Finish	Height (mm)	Width (mm)	Projection (mm)	Tube (mm)	Collector (mm)	Pipe centres (mm)	Weight (kg)	Litres	BTU*	Watts	Electric Immersion Rating Watts**
ARTIST												
ART40X1240OB	Onyx black	1240	400	202-210	50x10	30x30	370	15.86	4.01	1982	581	400
ART40X1240CM	Cashmere	1240	400	202-210	50x10	30x30	370	15.86	4.01	1982	581	400
ART40X1240SG	Storm grey	1240	400	202-210	50x10	30x30	370	15.86	4.01	1982	581	400
ART40X1240MW	Matt white	1240	400	202-210	50x10	30x30	370	15.86	4.01	1982	581	400
AIR												
AR50X1150MB	Metallic black	1150	500	117-125	50x10	30x30	470	14.5	3.16	1514	444	400
AR50X1150SW	Soft white	1150	500	117-125	50x10	30x30	470	14.5	3.16	1514	444	400
AR50X1630MB	Metallic black	1630	500	117-125	50x10	30x30	470	20.9	4.60	2197	644	600
AR50X1630SW	Soft white	1630	500	117-125	50x10	30x30	470	20.9	4.60	2197	644	600
MPRO												
MP48X1140MB	Matt black	1140	480	72-80	22 Ø	30x30	455	8.6	4.17	1607	471	400
MP48X1140MW	Matt white	1140	480	72-80	22 Ø	30x30	455	8.6	4.17	1607	471	400
MP48X1140F	Brushed brass	1140	480	72-80	22 Ø	30x30	455	8.6	4.17	1607	471	400
MP48X1380MB	Matt black	1380	480	72-80	22 Ø	30x30	455	10.3	5.02	1938	565	600
MP48X1380MW	Matt white	1380	480	72-80	22 Ø	30x30	455	10.3	5.02	1938	565	600
MP48X1380F	Brushed brass	1380	480	72-80	22 Ø	30x30	455	10.3	5.02	1938	565	600
MP48X1140MBELEC	Matt black	1140	480	72-80	22Ø	30x30	455	13.6	na	na	400	400
MP48X1140MWELEC	Matt white	1140	480	72-80	22Ø	30x30	455	13.6	na	na	400	400
MP48X1140FELEC	Brushed brass	1140	480	72-80	22Ø	30x30	455	13.6	na	na	400	400
MP48X1380MBELEC	Matt black	1380	480	72-80	22Ø	30x30	455	16.4	na	na	600	600
MP48X1380MWELEC	Matt white	1380	480	72-80	22Ø	30x30	455	16.4	na	na	600	600
MP48X1380FELEC	Brushed brass	1380	480	72-80	22Ø	30x30	455	16.4	na	na	600	600
INFINITY												
IF50X122B	Matt black	1228	500	60-70	22 Ø	40-30	45	9.5	5.9	2512	586	N/A
IF50X122C	Chrome	1228	500	60-70	22 Ø	40-30	45	9.5	5.9	1683	393	N/A
IF50X181B	Matt black	1813	500	60-70	22 Ø	40-30	45	13.5	8.6	3675	861	N/A
IF50X181C	Chrome	1813	500	60-70	22 Ø	40-30	45	13.5	8.6	2478	578	N/A
WEDGE												
WD50X109MB	Metallic black	1096	500	70	30x30	30x40	470	9	5.21	1385	406	300
WD50X109SW	Soft white	1096	500	70	30x30	30x40	470	9	5.21	1385	406	300
CELESTE												
CL50X111MB	Metallic black	1100	500	112-120	50x10	30x30	470	20.8	4.02	1887	553	600
CL50X111SW	Soft white	1100	500	112-120	50x10	30x30	470	20.8	4.02	1887	553	600
EDGE												
ED50X72C	Chrome	720	500	-	-	-	450	7.10	4.2	692	203	150
ED50X115C	Chrome	1150	500	-	-	-	450	11.30	7.4	1023	300	300
ED50X143C	Chrome	1420	500	-	-	-	450	14.10	8.9	1262	370	600
ED50X72A	Anthracite	720	500	-	-	-	450	7.10	4.2	1108	325	150
ED50X115A	Anthracite	1150	500	-	-	-	450	11.30	7.4	1665	488	300
ED50X143A	Anthracite	1420	500	-	-	-	450	14.10	8.9	2084	611	600
KAI												
KL50X80C	Chrome	800	500	-	-	-	57	3.8	2.8	860	203	200
KL50X100C	Chrome	1000	500	-	-	-	57	4.8	3.6	1103	259	300
KL50X120C	Chrome	1200	500	-	-	-	57	6.1	4.5	1341	315	300
KL50X160C	Chrome	1600	500	-	-	-	57	8.0	5.9	1799	420	300
KL50X80C	Anthracite	800	500	-	-	-	57	3.9	2.8	1270	300	300
KL50X100C	Anthracite	1000	500	-	-	-	57	4.9	3.6	1867	391	300
KL50X120C	Anthracite	1200	500	-	-	-	57	6.2	4.5	2027	478	500
KL50X160C	Anthracite	1600	500	-	-	-	57	8.1	5.9	2173	638	700

Metallic Black Matt / Soft White Matt Finishes Oxsilan® providing up to 65% more protection than standard zinc coating. High quality double layer Electro-static powder coating application for 100% surface coverage, massively reducing wear and tear and greater product lifetime. The most efficient heat output up to 20% higher than chrome. Self coloured metal wall fixings.

Chrome Finish Each rail is 100% wheel polished and sandblasted then electro chemically de-greased and bleached to prevent oxidising, ten: Nickel Primer 3micron / Copper coat 20-25 micron (for flatter surface and enhanced protection) / Nickel 20-25 micron / Chrome finish 0.5 micron - Result level 10 chrome plated finish.

Towel Warmer projection is between 75 - 100mm. Supplied with complete wall fixings and manual air vent. Manufactured from high grade mild steel conforming to EN 10305. Geometrical and surface finish - Round EN 10234 / EN ISO 4287, Flat Tube EN 10233 / EN ISO 4287, D Profile EN 10233 / EN ISO 4287. Fitted with 1/2" BSP connections. Tested to EN 442 ΔT = 50K All outputs certified to EN 442. To make an approximate conversion from T=50K to T=60K multiply outputs by 1.2.

**Summer Heating Elements are supplied with T Piece.

Electrical Information

The diagram below is supplied as a guide to Bathroom Zones as referred to in IP ratings of the over mirror lamps and electric heating elements. Please refer to the latest edition of BS 7671:2008(2011) to ensure conformity.

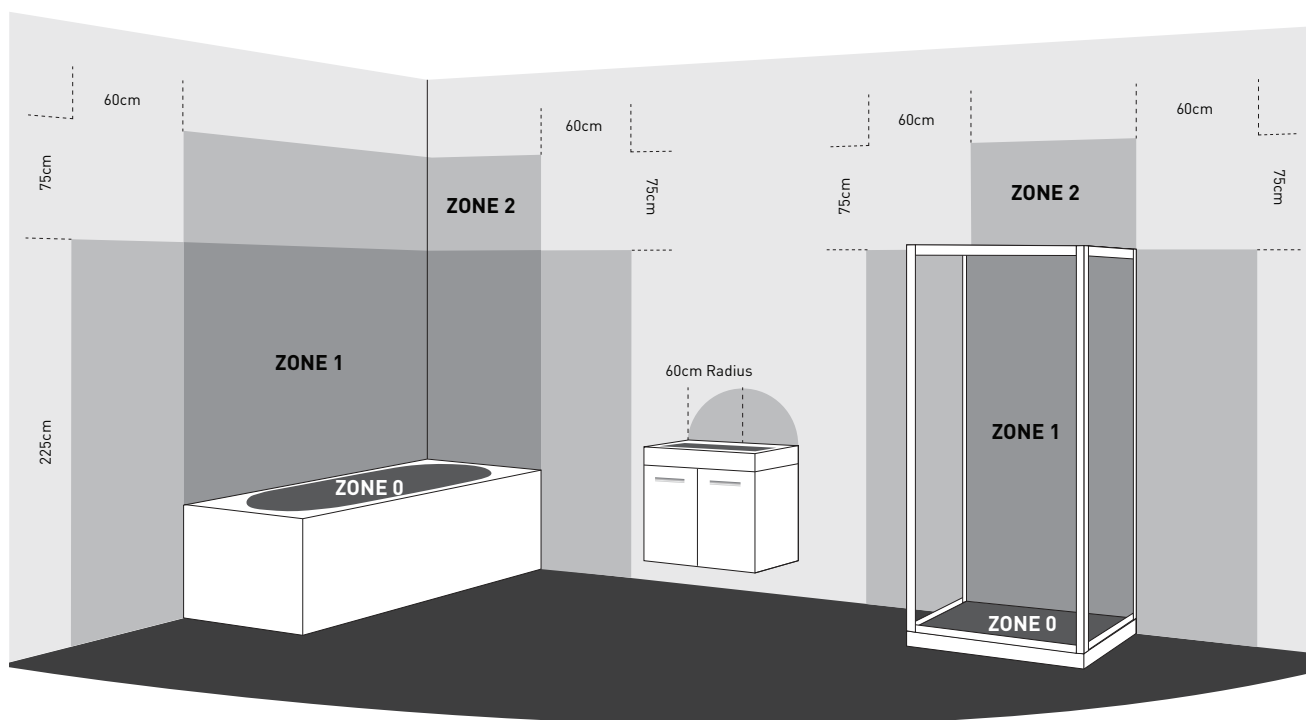

It is important to install light fittings and electric Towel Warmer elements in the correct bathroom zone i.e. the zone referred to in the IP rating of the element. This is not an installation guide and reference should be made to the latest edition of the IET Wiring Regulations or a qualified electrician member of NICEIC or IET.

Zone 0 is inside the bath or shower tray itself. Any appliance used in this zone must be rated at least IP67 which is total immersion proof.

Zone 1 is the area above the bath or shower tray to a height of 2.25m from the floor. In this zone a minimum rating of IP44 is required and elements must also be protected by a 30mA residual current device (RCD) to protect the circuit. The electrical connection to the power supply for these appliances must be in Zones 2/3 of the bathroom in compliance with BS 7671:2008(2011) - IEE Wiring Regulations.

Zone 2 is an area stretching 0.6m outside the perimeter of the bath and to a height of 2.25m from the floor. In this zone an IP rating of at least IP44 is required. In addition it is good practice to consider the area around a washbasin, within a 60cm radius of any tap to be considered as zone 2.

Crosswater IP44 lamps come without a pull switch, and are designed to operated via an existing and suitable room light switch.

Failure to have electrical products installed and certificated by a qualified electrical engineer will invalidate any product guarantee.

For full details reference should be made to the latest copy of the IEE wiring regulations and all applicable British Standard and European norm specifications.

Product Guidelines

Product Compatibility

While the majority of Crosswater products are compatible, care should be taken on product selection before ordering to avoid installation issues. The colours and finishes reproduced in this brochure are as accurate as the photography and printing process allows but may vary from the actual colours. Product sizes stated are nominal and should be checked against product. It is strongly advised that all bathrooms are well heated and ventilated.

Installation

All furniture ranges incorporate a factory fitted hanging system that allows safe and simple installation. Please ensure the correct wall fittings are used on solid or stud walls. Some furniture products are reversible for left or right hand door opening.

When installing a wall hung toilet or basin please ensure that appropriate fixings or suitable framework are used. When purchasing a wall hung toilet or basin on its own Crosswater does not supply fixings.

We strongly recommend all furniture and ceramics are fitted to a tiled surface, not tiled up to, this will assist any future maintenance. Due to the weight of some products you must ensure that the walls you are fixing to are of a suitable construction to support the product.

Vitreous China must not be put under stress during installation, if fittings are over tightened it creates stress within the ceramic material which may in time cause the failure of the product. Waste fittings should be carefully sealed in silicone and the back nut hand tightened, one additional final quarter turn using a suitable spanner is sufficient to create the required watertight seal. Care should also be taken when fitting brassware to prevent similar stress related failures. All products should be inspected before attempting installation.

It is the responsibility of the individual installer to ensure that products are fitted correctly and in line with the recommended fitting instructions provided. Failure to do so will invalidate the guarantee.

Cleaning

All Crosswater products should be cleaned as outlined below. Never use any aggressive fluids or strong household cleaning agents e.g. bleach, caustic soda or abrasive cleaners, which could damage the product.

Furniture should be wiped cleaned with a moist soft or micro fibre cloth. Any stubborn marks can be removed with diluted mild detergent.

Mirrors, cabinets and light fittings should be cleaned with a micro fibre cloth only, do not use "glass and mirror" cleaning products.

Sanitary ware, glass basins and ceramics should be cleaned after use by applying a little cream-type cleaner using a sponge or damp cloth and rinsed thoroughly with clean water. In hard water areas a good quality limescale remover can be applied.

Toilet seats should only be cleaned using a diluted mild detergent or warm soapy water; products containing bleach can lead to staining. Toilet seat hinges should be cleaned using a moist soft or micro fibre cloth. Any stubborn marks can be removed with diluted mild detergent.

Cast mineral resin basins should be cleaned using a diluted mild detergent or warm non-abrasive soapy water; in hard water areas a good quality limescale remover can be applied. Accidental spillages of household chemicals, nail polish or hair dye should be removed immediately by cleaning the surface with warm soapy water and then wiped dry.

Towel Warmers should be cleaned when cold with a moist soft or micro fibre cloth. Any stubborn surface or oxidation marks can be cleaned with Maas® Metal Polishing Crème, that will leave a long-lasting, fingerprint repelling protective finish.

Product Guarantee

All Crosswater products carry a comprehensive guaranteed for complete peace of mind.

All Crosswater guarantees are subject to online registration.

To register and activate your guarantee or for full details of all Crosswater guarantees, please visit www.crosswater.co.uk

Crosswater guarantees do not affect your statutory rights.

For further advice visit www.crosswater.co.uk





Find a local bathroom specialist at www.crosswater.co.uk

Expertise, design & aftercare

Specialist bathroom retailers can offer expert assistance with your bathroom design, providing full 3D plans to help you visualise and create your own perfect bathroom space. Once your bathroom is installed, they can offer a personal point of contact for any after sales support you may need, delivering complete peace of mind.

Experience the products

The purchase process is an emotional one. Specialist showrooms allow you to touch and feel a wide variety of bathroom products in relaxed surroundings while gaining inspiration from knowledgeable professionals who will explain the benefits of each product and make recommendations that match your personal preferences.

crosswater^x

Lake View House, Rennie Drive, Dartford, Kent DA1 5FU

crosswater.co.uk



Part of the Bathroom Brands Group

