

MERLYN™

Q

THE EASIEST DOOR YOU WILL EVER FIT

WWW.MERLYNSHOWERING.COM

✓
**NO SCREWS
ON FRAME**

✓
**NO DRILLING
ON FRAME**

✓
**CLICK ON
ROLLERS**

✓
**ASSEMBLED
ON TRAY**



MERLYN IQ – *the easiest shower door you will ever fit!*

The innovative MERLYN IQ range takes the hassle out of fitting. The unique patented easy-fit mechanism makes fitting MERLYN IQ simple and easy to install.

Unlike standard shower doors, MERLYN IQ is a one person install, uses no screws on the frame assembly and is built on the tray. This makes it perfect for fitting in smaller bathrooms and en-suites. The slot and lock fittings dramatically eliminate the need for any screws or drilling on the frame assembly.

The easy-fit rollers and clever installation tools all make MERLYN IQ the easiest door you will ever fit!

Slider, Quadrants and Corner doors are under **British Patent No. 2,580,730**



CONTENTS

| | |
|----------------------|-----------|
| Why Choose MERLYN IQ | 1 |
| Key Features | 3 |
| Sliding Door | 4 |
| Pivot Door | 5 |
| Bifold Door | 6 |
| One Door Quadrant | 7 |
| Two Door Quadrant | 8 |
| Extension Profiles | 9 |
| Bath Screens | 10 |
| Slip Resistant Trays | 12 |
| Touchstone Trays | 14 |
| Product Information | 16 |

MERLYN™



THE EASIEST DOOR YOU WILL EVER FIT

SLOT & LOCK FRAME SYSTEM - NO SCREWS

NO DRILLING ON FRAME

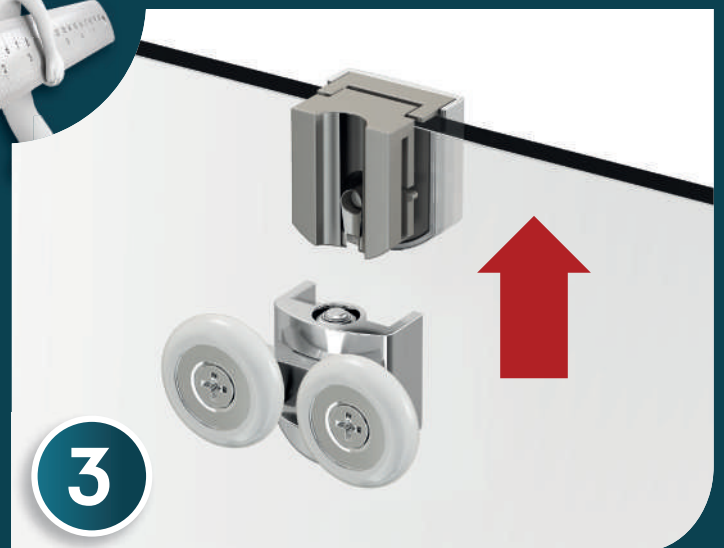

ASSEMBLED ON TRAY

CLICK ON ROLLERS

*SCAN
HERE* →

www.merlynshowering.com



EXTENSIVE RANGE OF **34 SIZE** OPTIONS AVAILABLE AS WELL AS TRAY OPTIONS TO SUIT EACH SPACE!

| Product | Size | Door | Touchstone Tray | Touchstone-SR | Bath Screen |
|---------------------------|-------------|------|-----------------|---------------|-------------|
| Sliding Door | 1000 | √ | √ | √ | |
| | 1100 | √ | √ | √ | |
| | 1200 | √ | √ | √ | |
| | 1400 | √ | √ | √ | |
| | 1500 | √ | √ | √ | |
| | 1600 | √ | √ | √ | |
| | 1700 | √ | √ | √ | |
| One Door Quadrant | 800 | √ | √ | √ | |
| | 900 | √ | √ | √ | |
| | 1000x800 | √ | √ | √ | |
| | 1200x800 | √ | √ | √ | |
| | 1200x900 | √ | √ | √ | |
| Two Door Quadrant | 800 | √ | √ | √ | |
| | 900 | √ | √ | √ | |
| Two Door Offset Quadrant | 900 x 760 | √ | √ | √ | |
| | 900 x 800 | √ | | | |
| | 1000 x 800 | √ | √ | √ | |
| | 1200 x 800 | √ | √ | √ | |
| | 1200 x 900 | √ | √ | √ | |
| Pivot Door | 700 | √ | √ | | |
| | 760 | √ | √ | | |
| | 800 | √ | √ | √ | |
| | 900 | √ | √ | √ | |
| | 1000 | √ | √ | √ | |
| Bifold Door | 700 | √ | √ | | |
| | 760 | √ | √ | | |
| | 800 | √ | √ | √ | |
| | 900 | √ | √ | √ | |
| | 1000 | √ | √ | √ | |
| Side Panels | 700 | √ | √ | √ | |
| | 760 | √ | √ | √ | |
| | 800 | √ | √ | √ | |
| | 900 | √ | √ | √ | |
| | 1000 | √ | √ | √ | |
| Single Curved | 800 x 1500 | | | | √ |
| Single Squared | 800 x 1500 | | | | √ |
| Two Panel Curved | 1150 x 1500 | | | | √ |
| Two Panel Folding Curved | 1150 x 1500 | | | | √ |
| Two Panel Folding Squared | 900 x 1500 | | | | √ |
| Two Panel Hinged | 900 x 1500 | | | | √ |



MERLYN's new easy fitting range assembled on tray!

scan here for more information →

ONE PERSON FIT



KEY FEATURES

6_{MM}
GLASS
THICKNESS

1900
MM
HEIGHT
STANDARD RANGE

MERSHIELD
STAYCLEAR

10yr.
Guarantee

CLICK ON ROLLERS



Rollers come completely pre-assembled and simply click onto the fixing.

EASY CLEAN ROLLERS

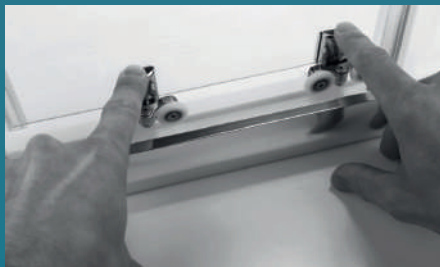

All rollers on MERLYN IQ products are now double quick release for easy cleaning.

NO VISIBLE SCREWS OR FIXINGS



There are no visible screws on the wall profile or side panel profiles, making this door easier to clean.

UK
CA

All MERLYN IQ doors are manufactured in accordance with BS EN 14428.



MERLYN IQ installation tool. Makes fitting even easier.
**Not included with the Bifold or Pivot door.*



MERLYN BRANDED
DESIGNER HANDLE

UNIQUE FITTING SYSTEM

1 SLIDING & QUADRANTS



2 PIVOT & BIFOLD



3 SIDE PANEL

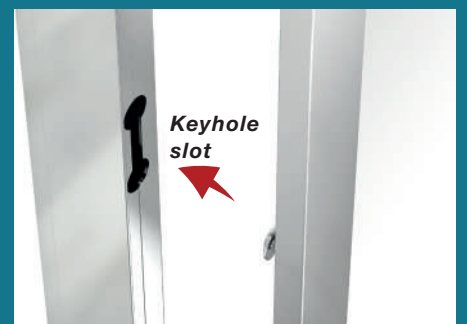

Keyhole
slot

SLIDING DOOR



Sliding Door with Side Panel shown as Left Hand (L)

Key Features

- ▶ Height 1900mm
- ▶ 6mm Toughened Safety Glass
- ▶ Easy Clean Frame
- ▶ Reversible
- ▶ Mershield™ Easy Clean Glass
- ▶ Chrome Designer Handle
- ▶ 10 Year Guarantee

Sliding Door

| Size | Adjustment in Recess Min - Max | Adjustment with Side Panel Min - Max | Order Code | Price £ Ex. VAT | Price £ Inc. VAT |
|------|--------------------------------|--------------------------------------|------------|-----------------|------------------|
| 1000 | 950-990 | 960-1000 | KAS10 | 542.35 | 650.82 |
| 1100 | 1050-1090 | 1060-1100 | KAS11 | 542.35 | 650.82 |
| 1200 | 1150-1190 | 1160-1200 | KAS12 | 542.35 | 650.82 |
| 1400 | 1350-1390 | 1360-1400 | KAS14 | 636.80 | 764.16 |
| 1500 | 1450-1490 | 1460-1500 | KAS15 | 656.83 | 788.20 |
| 1600 | 1550-1590 | 1560-1600 | KAS16 | 671.15 | 805.38 |
| 1700 | 1650-1690 | 1660-1700 | KAS17 | 694.04 | 832.85 |

Optional Side Panel

| Size | Adjustment Min - Max | Order Code | Price £ Ex. VAT | Price £ Inc. VAT |
|------|----------------------|------------|-----------------|------------------|
| 700 | 670-690 | KASP70 | 284.77 | 341.73 |
| 760 | 730-750 | KASP76 | 284.77 | 341.73 |
| 800 | 770-790 | KASP80 | 284.77 | 341.73 |
| 900 | 870-890 | KASP90 | 307.67 | 369.20 |
| 1000 | 970-990 | KASP10 | 384.95 | 461.94 |

Technical Drawing



A = Door Opening
B = Fixed Panel

| Code | A | B |
|-------|-----|-----|
| KAS10 | 375 | 435 |
| KAS11 | 425 | 485 |
| KAS12 | 475 | 535 |
| KAS14 | 575 | 635 |
| KAS15 | 575 | 735 |
| KAS16 | 575 | 835 |
| KAS17 | 575 | 935 |



SLIDING DOOR IN RECESS

scan here for fitting information



PIVOT DOOR



Frame Locking System



Pivot Door with Side Panel shown as Left Hand (L)

Key Features

- ▶ Height 1900mm
- ▶ 6mm Toughened Safety Glass
- ▶ Easy Clean Frame
- ▶ Reversible
- ▶ Mershield™ Easy Clean Glass
- ▶ Chrome Designer Handle
- ▶ 10 Year Guarantee

Pivot Door

| Size | Adjustment in Recess Min - Max | Adjustment with Side Panel Min - Max | Order Code | Price £ Ex. VAT | Price £ Inc. VAT |
|------|--------------------------------|--------------------------------------|------------|-----------------|------------------|
| 700 | 650-690 | 655-675 | KAP70 | 427.87 | 513.45 |
| 760 | 710-750 | 715-735 | KAP76 | 450.77 | 540.92 |
| 800 | 750-790 | 755-775 | KAP80 | 450.77 | 540.92 |
| 900 | 850-890 | 855-875 | KAP90 | 479.39 | 575.27 |
| 1000 | 950-990 | 955-975 | KAP10 | 508.01 | 609.61 |

Technical Drawing



A = Door Opening
B = Door Swing

| Code | A | B |
|-------|-----|-----|
| KAP70 | 455 | 460 |
| KAP76 | 515 | 525 |
| KAP80 | 535 | 540 |
| KAP90 | 610 | 605 |
| KAP10 | 660 | 655 |

Optional Side Panel

| Size | Adjustment Min - Max | Order Code | Price £ Ex. VAT | Price £ Inc. VAT |
|------|----------------------|------------|-----------------|------------------|
| 700 | 662-682 | KASP70 | 284.77 | 341.73 |
| 760 | 722-742 | KASP76 | 284.77 | 341.73 |
| 800 | 762-782 | KASP80 | 284.77 | 341.73 |
| 900 | 862-882 | KASP90 | 307.67 | 369.20 |
| 1000 | 962-982 | KASP10 | 384.95 | 461.94 |

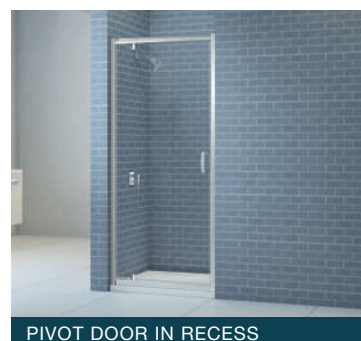

scan here for fitting information



BIFOLD DOOR



Frame Locking System



Bifold Door with Side Panel shown as Left Hand (L)

Key Features

- ▶ Height 1900mm
- ▶ 6mm Toughened Safety Glass
- ▶ Easy Clean Frame
- ▶ Reversible
- ▶ Mershield™ Easy Clean Glass
- ▶ Chrome Designer Handle
- ▶ 10 Year Guarantee

Bifold Door

| Size | Adjustment in Recess Min - Max | Adjustment with Side Panel Min - Max | Order Code | Price £ Ex. VAT | Price £ Inc. VAT |
|------|--------------------------------|--------------------------------------|------------|-----------------|------------------|
| 700 | 650-690 | 655-675 | KAB70 | 499.43 | 599.31 |
| 760 | 710-750 | 715-735 | KAB76 | 499.43 | 599.31 |
| 800 | 750-790 | 755-775 | KAB80 | 499.43 | 599.31 |
| 900 | 850-890 | 855-875 | KAB90 | 528.05 | 633.66 |
| 1000 | 950-990 | 955-975 | KAB10 | 570.97 | 685.17 |

Technical Drawing

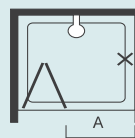

A = Door Opening

| Size | A |
|------|-----|
| 700 | 415 |
| 760 | 460 |
| 800 | 490 |
| 900 | 570 |
| 1000 | 650 |

Optional Side Panel

| Size | Adjustment Min - Max | Order Code | Price £ Ex. VAT | Price £ Inc. VAT |
|------|----------------------|------------|-----------------|------------------|
| 700 | 662-682 | KASP70 | 284.77 | 341.73 |
| 760 | 722-742 | KASP76 | 284.77 | 341.73 |
| 800 | 762-782 | KASP80 | 284.77 | 341.73 |
| 900 | 862-882 | KASP90 | 307.67 | 369.20 |
| 1000 | 962-982 | KASP10 | 384.95 | 461.94 |

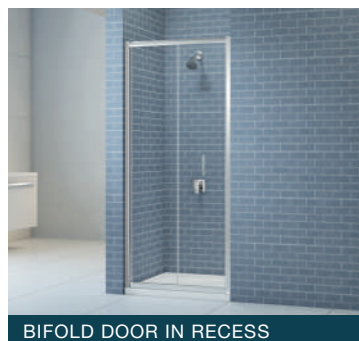

BIFOLD DOOR IN RECESS

scan here for fitting information



ONE DOOR QUADRANTS



Slot



Secure



Click on
Rollers



1 Door Quadrant shown as Right Hand (R)

Key Features

- ▶ Height 1900mm
- ▶ 6mm Toughened Safety Glass
- ▶ Easy Clean Frame
- ▶ Reversible
- ▶ Mershield™ Easy Clean Glass
- ▶ Chrome Designer Handle
- ▶ 10 Year Guarantee

One Door Quadrants

| Size | Adjustment Min - Max | Order Code | Price £ Ex. VAT | Price £ Inc. VAT |
|-------------|-------------------------|------------|--------------------|---------------------|
| 800 x 800 | 770-790 | KA1Q80 | 699.77 | 839.72 |
| 900 x 900 | 870-890 | KA1Q90 | 699.77 | 839.72 |
| 1000 x 1000 | 970-990 | KA1Q100 | 828.55 | 994.26 |

Technical Drawing

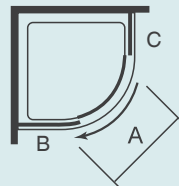

A = Opening space
B = Fixed Curved Panel
C = Fixed Straight Panel

| Code | A | B | C |
|---------|-----|-----|-----|
| KA1Q80 | 435 | 490 | 215 |
| KA1Q90 | 485 | 530 | 325 |
| KA1Q100 | 485 | 630 | 425 |
| KA1Q108 | 435 | 490 | 425 |
| KA1Q128 | 435 | 490 | 625 |
| KA1Q129 | 485 | 530 | 625 |

One Door Offset Quadrants

| Size | Adjustment Min - Max | Order Code | Price £ Ex. VAT | Price £ Inc. VAT |
|------------|-------------------------|------------|--------------------|---------------------|
| 1000 x 800 | 970-990/ 770-790 | KA1Q108 | 814.25 | 977.10 |
| 1200 x 800 | 1170-1190/ 770-790 | KA1Q128 | 842.87 | 1011.44 |
| 1200 x 900 | 1170-1190/ 870-890 | KA1Q129 | 880.07 | 1056.08 |



1 DOOR OFFSET QUADRANTS

scan here for
fitting information



TWO DOOR QUADRANTS



Slot



Secure



Click on Rollers



2 Door Quadrant shown as Left and Right Hand (L+R)

Key Features

- ▶ Height 1900mm
- ▶ 6mm Toughened Safety Glass
- ▶ Easy Clean Frame
- ▶ Reversible
- ▶ Mershiel™ Easy Clean Glass
- ▶ Chrome Designer Handle
- ▶ 10 Year Guarantee

Two Door Quadrants

| Size | Adjustment Min - Max | Order Code | Price £ Ex. VAT | Price £ Inc. VAT |
|-----------|-------------------------|------------|--------------------|---------------------|
| 800 x 800 | 770-790 | KA2Q80 | 513.73 | 616.48 |
| 900 x 900 | 870-890 | KA2Q90 | 513.73 | 616.48 |

Two Door Offset Quadrants

| Size | Adjustment Min - Max | Order Code | Price £ Ex. VAT | Price £ Inc. VAT |
|------------|-------------------------|------------|--------------------|---------------------|
| 900 x 760 | 870-890/ 730-750 | KA2Q976 | 579.56 | 695.48 |
| 900 x 800 | 870-890/ 770-790 | KA2Q980 | 613.91 | 736.69 |
| 1000 x 800 | 970-990/ 770-790 | KA2Q108 | 622.49 | 746.99 |
| 1200 x 800 | 1170-1190/ 770-790 | KA2Q128 | 656.83 | 788.20 |
| 1200 x 900 | 1170-1190/ 870-890 | KA2Q129 | 685.45 | 822.54 |

Technical Drawing

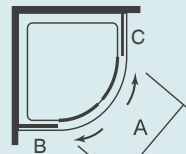

A = Door Opening
B = Flat Fixed Panel
C = Flat Fixed Panel

| Code | A | B | C |
|---------|-----|-----|-----|
| KA2Q80 | 385 | 225 | 225 |
| KA2Q90 | 545 | 325 | 325 |
| KA2Q976 | 435 | 325 | 185 |
| KA2Q980 | 470 | 325 | 225 |
| KA2Q108 | 470 | 425 | 225 |
| KA2Q128 | 470 | 625 | 225 |
| KA2Q129 | 545 | 625 | 325 |



2 DOOR OFFSET QUADRANTS

scan here for
fitting information



EXTENSION PROFILES

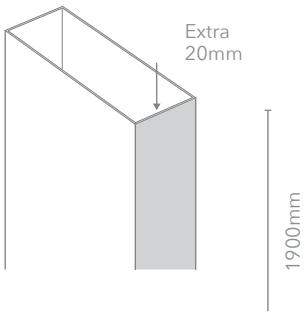

SLIDING DOOR

| Order Code | Height | Price £ Ex. VAT | Price £ Inc. VAT |
|----------------------|--------|-----------------|------------------|
| KAE1 | 1900 | 83.00 | 99.60 |
| Side Panel Extension | | | |
| KAE3 | 1900 | 83.00 | 99.60 |

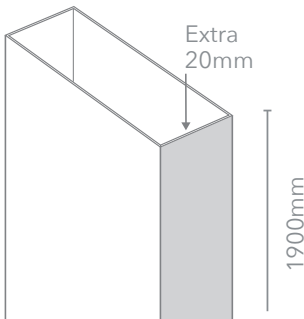

PIVOT / BIFOLD DOOR

| Order Code | Height | Price £ Ex. VAT | Price £ Inc. VAT |
|----------------------|--------|-----------------|------------------|
| KAE2 | 1900 | 83.00 | 99.60 |
| Side Panel Extension | | | |
| KAE3 | 1900 | 83.00 | 99.60 |

UKCA, CE & EN INFORMATION

The UKCA (UK Conformity Assessment) mark on MERLYN enclosures is the new standard marking for products on the market in Great Britain (England, Wales and Scotland). It is a declaration that the product complies with GB designated standards.

The CE markings on MERLYN enclosures is a declaration that the product complies with the essential requirements of the relevant European health, safety and environmental protection legislation.

EU and GB legislation requires manufacturers to display either the UKCA mark for Great Britain and a CE mark for the EU and Northern Ireland on their product or packaging. It is an offence to place a product on the relevant market without a UKCA for Great Britain or CE marking for the EU market.

The manufacturer is legally responsible for ensuring that the product conforms to the requirements of both directives.

The European Commission thus refers to the CE marking as a "Passport" which allows products to be freely circulated within the EU single market. The UKCA marking allows products to move freely within Great Britain.

Often consumers will consider the UKCA and CE markings on a product as an indication of conformance to laid down minimum standards and therefore, a minimum level of safety which other products may lack. Both markings are often seen by consumers as a "Symbol of Safety."

| | |
|--|--|
| UKCA | |
| CE | |
| UK Distributor: Merlyn (a division of NGHLL), Ladyfield House, Station Rd, Wilmslow, Cheshire, SK9 1BU. | Manufacturer: Merlyn Industries Limited, Unit 8, Purcellstown Ind. Estate, Kilkenny, Ireland, R95 HP71. |
| 19 | |
| UKCA DOP: UKCATZ1.1 CE DOP: CETZ1.1 | |
| Product Code here (MER01) | |
| PH | |
| EN 14428 | |
| CA/IR/DA | |



MERLYN invests heavily in its product development and as such guarantees that its glass fully complies with regulations and is manufactured in accordance with **BS EN 14428**. The rigorous testing of the glass ensures that the endurance, stability and water retention criteria meet high industry standards.

MERLYN

EASY-FIT

An innovative way to replace your bath screen without the need to re-drill the wall. Simply connect your easy-fit to the existing holes in the wall and install your new bath screen.

Fitting Steps

Easy-Fit profile



1

REMOVE THE OLD PROFILE

2

POSITION THE EASY-FIT PROFILE ON THE WALL

3

ADJUST THE BRACKETS TO ALIGN TO THE EXISTING HOLES AND FIX IN POSITION



Scan me to see more

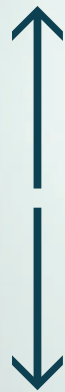

Slide bracket up to align with hole



Available with the MB1 / MB2 / MB3 / MB3A / MB3B and MB3C Bath Screens



Now featuring
HydraSEAL

Single Curved

| Size | Panel | Order Code | Price £ Exc. VAT | Price £ Inc. VAT |
|------------|-------|------------|---------------------|---------------------|
| 800 x 1500 | 1 | MB1FLEX | 279.31 | 335.17 |

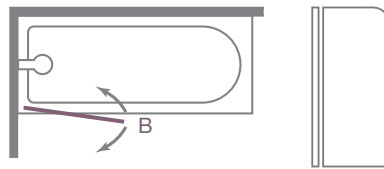

Door Swing: 90° in and out
B: Radius of Screen Swing = 733mm
☐ Recommended shower head position

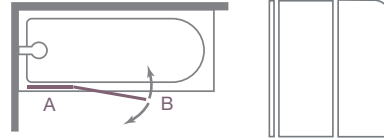

Door Swing: 90° in and out
A: Fixed Panel B: Radius of Screen Swing = 483mm
☐ Recommended shower head position



Now featuring
HydraSEAL

2 Panel Folding Curved

| Size | Panel | Order Code | Price £ Exc. VAT | Price £ Inc. VAT |
|------------|-------|------------|---------------------|---------------------|
| 900 x 1500 | 2 | MB3AFLEX | 416.18 | 499.42 |



Now featuring
HydraSEAL

Single Squared

| Size | Panel | Order Code | Price £ Exc. VAT | Price £ Inc. VAT |
|------------|-------|------------|---------------------|---------------------|
| 800 x 1500 | 1 | MB2FLEX | 317.67 | 381.20 |

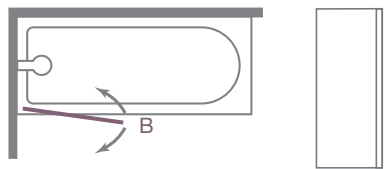

Door Swing: 90° in and out
B: Radius of Screen Swing = 733mm
☐ Recommended shower head position

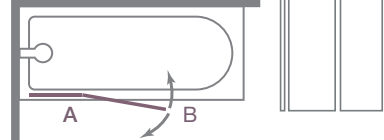

Door Swing: 90° in and out
A: Fixed Panel B: Radius of Screen Swing = 483mm
☐ Recommended shower head position



Now featuring
HydraSEAL

2 Panel Folding Square

| Size | Panel | Order Code | Price £ Exc. VAT | Price £ Inc. VAT |
|------------|-------|------------|---------------------|---------------------|
| 900 x 1500 | 2 | MB3BFLEX | 416.18 | 499.42 |



Now featuring
HydraSEAL

2 Panel Curved

| Size | Panel | Order Code | Price £ Exc. VAT | Price £ Inc. VAT |
|-------------|-------|------------|---------------------|---------------------|
| 1150 x 1500 | 2 | MB3FLEX | 656.06 | 787.27 |

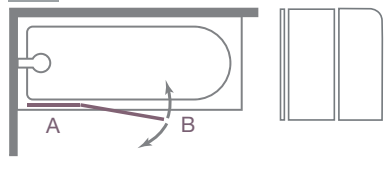

Door Swing: 90° in and out
A: Fixed Panel B: Radius of Screen Swing = 733mm
☐ Recommended shower head position

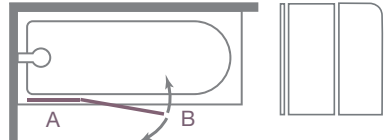

Door Swing: 90° in and out
A: Fixed Panel = 471mm
B: Radius of Screen Swing = 335mm
☐ Recommended shower head position



Now featuring
HydraSEAL

2 Panel Hinged

| Size | Panel | Order Code | Price £ Exc. VAT | Price £ Inc. VAT |
|------------|-------|------------|---------------------|---------------------|
| 900 x 1500 | 2 | MB3CFLEX | 416.18 | 499.42 |

SLIP RESISTANT TRAYS

Our slip resistant shower trays have a textured acrylic finish which is formed into the top ABS layer during production. This reveals a property that ensures maximum safety in the shower and gives a very natural feeling, which is also warm and pleasant to the touch.



This ranks MERLYN in a premium class.

key benefits of a MERLYN Slip Resistant Tray



EASY CLEAN

All you need is a soft cloth and warm soapy water.



QUALITY LOOK AND FEEL

The luxury satin look and feel is designed to give confidence while not feeling harsh underfoot.



TOUCHSTONE-SR

Designed in a beautiful matt white finish without the harsh surface texture sometimes experienced in a slip resistant finish. Best in class - Exceeding the requirements in two independently tested industry standards.

Features & Benefits

- ▶ 10 Year Guarantee
- ▶ Single skinned with moulded solid under section
- ▶ 50mm high to achieve minimalist design
- ▶ Slip Resistant is manufactured into the coating and won't wear
- ▶ 135mm high including tray panel kit
- ▶ Compatible 90mm fast flow waste also available

Rectangular Tray

| Size | Code | Tray Panel Kit | Price £ Exc. VAT | Price £ Inc. VAT |
|------------|-------------|----------------|---------------------|---------------------|
| 900 x 800 | S980RTASTO | Kit 4 | 251.75 | 302.10 |
| 1000 x 800 | S108RTASTO | Kit 4 | 259.98 | 311.98 |
| 1000 x 900 | S109RTASTO | Kit 4 | 269.95 | 323.94 |
| 1100 x 800 | S118RTASTO | Kit 4 | 269.95 | 323.94 |
| 1200 x 700 | S127RTASTO | Kit 4 | 269.95 | 323.94 |
| 1200 x 760 | S1276RTASTO | Kit 4 | 282.83 | 339.39 |
| 1200 x 800 | S128RTASTO | Kit 4 | 299.80 | 359.76 |
| 1200 x 900 | S129RTASTO | Kit 4 | 321.77 | 386.12 |
| 1400 x 700 | S147RTASTO | Kit 3 | 430.11 | 516.13 |
| 1400 x 800 | S148RTASTO | Kit 3 | 430.11 | 516.13 |
| 1400 x 900 | S149RTASTO | Kit 3 | 453.34 | 544.01 |
| 1500 x 760 | S1576RTASTO | Kit 3 | 504.64 | 605.56 |
| 1500 x 800 | S158RTASTO | Kit 3 | 504.64 | 605.56 |
| 1500 x 900 | S159RTASTO | Kit 3 | 531.18 | 637.42 |
| 1600 x 700 | S167RTASTO | Kit 3 | 563.10 | 675.72 |
| 1600 x 800 | S168RTASTO | Kit 3 | 563.10 | 675.72 |
| 1600 x 900 | S169RTASTO | Kit 3 | 591.24 | 709.49 |
| 1685 x 700 | S177RTASTO | Kit 3 | 610.00 | 732.00 |
| 1700 x 800 | S178RTASTO | Kit 3 | 684.16 | 820.99 |
| 1700 x 900 | S179RTASTO | Kit 3 | 736.94 | 884.32 |

Kit to be ordered separately

Offset Quadrant Tray

| Size | Code | Tray Panel Kit | Price £ Exc. VAT | Price £ Inc. VAT |
|---------------|------------|----------------|---------------------|---------------------|
| 1000 x 800 LH | S108QLASTO | Kit 1 | 284.78 | 341.74 |
| 1000 x 800 RH | S108QRASTO | Kit 1 | 284.78 | 341.74 |
| 1200 x 800 LH | S128QLASTO | Kit 1 | 299.80 | 359.76 |
| 1200 x 800 RH | S128QRASTO | Kit 1 | 299.80 | 359.76 |
| 1200 x 900 LH | S129QLASTO | Kit 1 | 353.75 | 424.50 |
| 1200 x 900 RH | S129QRASTO | Kit 1 | 353.75 | 424.50 |

This product is handed – please choose L for Left and R for Right when ordering.

Quadrant Tray

| Size | Code | Tray Panel Kit | Price £ Exc. VAT | Price £ Inc. VAT |
|-----------|----------|----------------|---------------------|---------------------|
| 800 x 800 | S80QASTO | Kit 2 | 187.66 | 225.19 |
| 900 x 900 | S90QASTO | Kit 2 | 209.84 | 251.81 |

Square Tray

| Size | Code | Tray Panel Kit | Price £ Exc. VAT | Price £ Inc. VAT |
|-----------|-----------|----------------|---------------------|---------------------|
| 800 x 800 | S80SQASTO | Kit 4 | 171.54 | 205.85 |
| 900 x 900 | S90SQASTO | Kit 4 | 198.12 | 237.75 |

Tray Panel Kits (including Legs)*** No Waste

| Tray Panel Kit | Code | Price £ Exc. VAT | Price £ Inc. VAT |
|----------------|------|---------------------|---------------------|
| Kit 1 | DRK1 | 131.96 | 158.35 |
| Kit 2 | DRK2 | 131.96 | 158.35 |
| Kit 3 | DRK3 | 131.96 | 158.35 |
| Kit 4 | DRK4 | 131.96 | 158.35 |

Waste Complete Only

| Code | Price £ Exc. VAT | Price £ Inc. VAT |
|------|---------------------|---------------------|
| DWAS | 39.06 | 46.87 |

Please Note: Price and order codes on the Touchstone-SR do not include waste, waste must be ordered separately. **Code: DWAS**



Graduated adjustable leg and easy-fit tray panel kit.



Graduated adjustable leg system.



90mm fast flow waste, includes hair trap and chrome cover.



TOUCHSTONE TRAYS



TOUCHSTONE

TOUCHSTONE

Rectangular Tray

Waste needs to be ordered separately

| Rectangular Tray | | | | |
|------------------|------------|----------------|------------------|------------------|
| Tray Size | Order Code | Tray Panel Kit | Price £ Exc. VAT | Price £ Inc. VAT |
| 800 x 700 | S870RTTO | Kit 4 | 174.01 | 208.81 |
| 800 x 760 | S876RTTO | Kit 4 | 174.01 | 208.81 |
| 900 x 700 | S970RTTO | Kit 4 | 190.15 | 228.18 |
| 900 x 760 | S976RTTO | Kit 4 | 190.15 | 228.18 |
| 900 x 800 | S980RTTO | Kit 4 | 190.15 | 228.18 |
| 1000 x 700 | S107RTTO | Kit 4 | 196.35 | 235.62 |
| 1000 x 760 | S1076RTTO | Kit 4 | 196.35 | 235.62 |
| 1000 x 800 | S108RTTO | Kit 4 | 196.35 | 235.62 |
| 1000 x 900 | S109RTTO | Kit 4 | 203.89 | 244.66 |
| 1100 x 800 | S118RTTO | Kit 4 | 203.89 | 244.66 |
| 1200 x 700 | S127RTTO | Kit 4 | 203.89 | 244.66 |
| 1200 x 760 | S1276RTTO | Kit 4 | 213.61 | 256.33 |
| 1200 x 800 | S128RTTO | Kit 4 | 226.42 | 271.70 |
| 1200 x 900 | S129RTTO | Kit 4 | 243.00 | 291.60 |
| 1300 x 800 | S138RTTO | Kit 3 | 315.39 | 378.47 |
| 1400 x 700 | S147RTTO | Kit 3 | 324.85 | 389.82 |
| 1400 x 760 | S1476RTTO | Kit 3 | 324.85 | 389.82 |
| 1400 x 800 | S148RTTO | Kit 3 | 324.85 | 389.82 |
| 1400 x 900 | S149RTTO | Kit 3 | 342.37 | 410.85 |
| 1500 x 700 | S157RTTO | Kit 3 | 360.95 | 433.14 |
| 1500 x 760 | S1576RTTO | Kit 3 | 381.12 | 457.34 |
| 1500 x 800 | S158RTTO | Kit 3 | 381.12 | 457.34 |
| 1500 x 900 | S159RTTO | Kit 3 | 401.17 | 481.40 |
| 1600 x 700 | S167RTTO | Kit 3 | 425.28 | 510.34 |
| 1600 x 800 | S168RTTO | Kit 3 | 425.28 | 510.34 |
| 1600 x 900 | S169RTTO | Kit 3 | 446.53 | 535.84 |
| 1685 x 700 | S177RTTO | Kit 3 | 460.70 | 552.85 |
| 1680 x 760 | S1776RTTO | Kit 3 | 474.88 | 569.85 |
| 1700 x 800 | S178RTTO | Kit 3 | 516.70 | 620.04 |
| 1700 x 900 | S179RTTO | Kit 3 | 556.56 | 667.87 |
| 1800 x 800 | S188RTTO | Kit 3 | 630.31 | 756.38 |

Waste needs to be ordered separately

| Square Tray | | | | |
|-------------|------------|----------------|------------------|------------------|
| Tray Size | Order Code | Tray Panel Kit | Price £ Exc. VAT | Price £ Inc. VAT |
| 760 x 760 | S76SQTO | Kit 4 | 115.63 | 138.76 |
| 800 x 800 | S80SQTO | Kit 4 | 129.57 | 155.48 |
| 900 x 900 | S90SQTO | Kit 4 | 149.64 | 179.56 |

| Rectangle Tray Panel Kits – Including Legs | | | | |
|--|------------|----------------|------------------|------------------|
| Tray Size | Order Code | Tray Panel Kit | Price £ Exc. VAT | Price £ Inc. VAT |
| 1700 x 900 | DRK3 | Kit 3 | 131.96 | 158.35 |
| 1200 x 900 | DRK4 | Kit 4 | 131.96 | 158.35 |

Key Features

- 50mm high to achieve minimalist design
- 135mm high including tray panel set
- ABS acrylic sheets capped with an easy-clean surface that provides a chemical resistant, anti-bacterial solution due to its ultra-smooth, non-porous surface. Available as low level or with tray panel kits for easy installation
- 10 Year Guarantee*

*This guarantee covers manufacturing defects only

Please Note: The 1700 x 800, 1700 x 900 and 1800 x 800 trays have a centre waste



TOUCHSTONE

Quadrant Tray

Waste needs to be ordered separately

| Quadrant Tray | | | | |
|---------------|------------|----------------|------------------|------------------|
| Tray Size | Order Code | Tray Panel Kit | Price £ Exc. VAT | Price £ Inc. VAT |
| 800 | S80QTO | Kit 2 | 141.76 | 170.12 |
| 900 | S90QTO | Kit 2 | 158.45 | 190.14 |

| Waste Complete Only | | | | |
|---------------------|------------|------------------|------------------|--|
| | Order Code | Price £ Exc. VAT | Price £ Inc. VAT | |
| Waste complete | DWAS | 39.06 | 46.87 | |

Tray Panel Kits (including Legs)*** No Waste

| Tray Panel Kit | | | | |
|----------------|------------|------------------|------------------|--|
| Kit | Order Code | Price £ Exc. VAT | Price £ Inc. VAT | |
| Kit 1 | DRK1 | 131.96 | 158.35 | |
| Kit 2 | DRK2 | 131.96 | 158.35 | |
| Kit 3 | DRK3 | 131.96 | 158.35 | |
| Kit 4 | DRK4 | 131.96 | 158.35 | |



Graduated adjustable leg and easy-fit tray panel kit.



TOUCHSTONE

Tray shown as Right Hand

Offset Quadrant Tray

Waste needs to be ordered separately

| Offset Quadrant Tray | | | | |
|----------------------|------------|----------------|------------------|------------------|
| Tray Size | Order Code | Tray Panel Kit | Price £ Exc. VAT | Price £ Inc. VAT |
| Right Hand | | | | |
| 1000 x 800 | S108QRTO | Kit 1 | 215.08 | 258.10 |
| 1200 x 800 | S128QRTO | Kit 1 | 226.42 | 271.70 |
| 1200 x 900 | S129QRTO | Kit 1 | 267.16 | 320.59 |
| Left Hand | | | | |
| 1000 x 800 | S108QLTO | Kit 1 | 215.08 | 258.10 |
| 1200 x 800 | S128QLTO | Kit 1 | 226.42 | 271.70 |
| 1200 x 900 | S129QLTO | Kit 1 | 267.16 | 320.59 |

This product is handed – please choose L for Left or R for Right when ordering.

| Offset Quadrant Tray Panel Kit – Including Legs | | | | |
|---|------------|----------------|------------------|------------------|
| Tray Size | Order Code | Tray Panel Kit | Price £ Exc. VAT | Price £ Inc. VAT |
| 1200 x 900 | DRK1 | Kit 1 | 131.96 | 158.35 |



Graduated adjustable leg system.



90mm fast flow waste, includes hair trap and chrome cover.

PRODUCT INFORMATION

All MERLYN IQ products are manufactured in accordance with BS EN 14428 and utilise toughened safety glass to EN 12150.

All doors feature adjustable wall profiles to compensate for out-of-true walls to obtain a perfect fit and operating action.

All enclosures are power shower approved – will retain water under normal showering conditions.

Water retention is maintained in all products under normal showering conditions.

Opened cartons cannot be returned. Returns over 30 days old will not be accepted. Returns carry a £40 box charge or £60 per unit.

All products are supplied complete with full installation instructions and the necessary fixings.

Check with your dealer for accurate matching of material samples.

Our policy of reviewing product design and development on a regular basis means MERLYN reserve the right to change product specifications and prices without notice.

IQ shower enclosures and Touchstone trays are covered by 10 year MERLYN Guarantee.

Please contact the MERLYN sales team for more details.

Glass shattering and parts subject to wear are not covered by your guarantee.

Lifestyle images are for illustrated purposes only. The colours and finishes shown in the catalogue are as accurate as possible within the limits of the printing process. The positioning of all showering heads in the brochure is for illustrative purposes only.

All descriptions, specifications and particulars contained in this brochure are intended merely to represent a general idea of the products described herein and none of these form part of any contract to give rise to any independent or collateral liability upon the company.

Adjustment

These are the minimum and maximum dimensions/adjustments of the enclosure itself - excluding the tray. Therefore, these are the dimensions to follow when installing an enclosure in a wetroom application without a tray.

Cleaning

It is important to clean your MERLYN IQ shower door after every use.

- Wipe down all the glass and metal parts with a soft cloth.
- Do not allow limescale to build up in hard water areas.
- Ensure that any residual water on the glass is removed after every use.
- Clean the glass regularly using soapy water.
- Do not use abrasive products on any surfaces.
- Install the enclosure in a well ventilated area.
- For more information on Mersfield Stayclear™ glass please visit www.merlynshowering.com.

Information and Maintenance

Always read the instructions on the packaging, chrome is vulnerable to acid attack. Strong household cleaners including strong disinfectants, denture cleaners, hair dyes, wine making chemicals and photographic chemicals may contain acid. These materials may have a varying effect on the surface from black spots/streaks (which cannot be removed) to pitting on the surface. Contact with these materials should be avoided.

Important shower tray information

Although shower door and enclosure sizes are related to tray sizes it is important to note that most shower trays are tiled down to the rim, often over an “up-stand”. The finished installation space may be less than the nominal tray size.

Dimensions given in this publication are in millimetres, are approximate and may vary with adjustment. They are subject to change without notice.

Please note that when a tray is fitted it is essential that the tray is level before any doors or enclosures are fitted.

MERLYN invests heavily in its product development and as such guarantees that its glass fully complies with regulations and its manufactured in accordance with BS EN 14428.

The rigorous testing of the glass ensures that the endurance, stability and water retention criteria meet high industry standards.

Please Note

Prices are correct at time of print April 2023. E&OE.

Due to circumstances beyond our control, prices may be altered including changes to the rate of VAT. Due to our policy of continuous improvement, we reserve the right to amend prices, specifications and designs without prior notice. Images are for illustrative purposes only.

ISO Certification

MERLYN has implemented an Integrated Management System comprising of Quality Management, Environmental Management and Occupational Health and Safety Management. An Integrated Management System ensures the seamless integration of several different standards into a common system that meets the requirements of each of these standards. These certifications are proof of MERLYN's credibility but also to instill confidence in our potential clients that MERLYN will keep its promises.



MERLYN™

Unit 8, Purcellsinch Industrial Estate, Dublin Road, Kilkenny, Ireland, R95 HP71.

T 0808 1011 429 / F 0808 1011 428

E sales@merlyn.ie / technical@merlyn.ie

www.merlynshowering.com



MERLYN™

